

WHEEL of FORTUNE™



OWNERS AND SERVICE MANUAL

INNOVATIVE CONCEPTS IN ENTERTAINMENT INC.

10123 MAIN STREET, CLARENCE, NY 14031

SERVICE: 1-716-759-0360

FAX: 1-716-759-0884

E-MAIL: service@icegame.com

WEBSITE: icegame.com

TABLE OF CONTENTS

INTRODUCTION

GAME FEATURES
GAME PLAY

INSTALLATION

BEFORE YOU BEGIN
INSTALLATION

PROGRAMMING OPTIONS

INTRODUCTION
HOW TO ADJUST OPTIONS
USING THE PROGRAMMING OPTIONS

MAINTENANCE

QUICK TROUBLESHOOTING

GAME REPAIR

OPERATIONAL BACKGROUND
TROUBLESHOOTING PHILOSOPHY
MECHANICAL REPAIR

PARTS LISTINGS

SCHEMATICS

WARRANTY INFORMATION

INTRODUCTION

GAME FEATURES

Thank you for purchasing the new Wheel of Fortune™ game from I.C.E. By combining the great play appeal of "Cyclone", the great name recognition of the immensely popular TV show "Wheel of Fortune", and by adding the spinning wheel and great game sounds, we've taken the "Quick coin" game to a new level. You'll find this game to be a huge money earner now and for years to come.

Game cabinetry is stylish, yet bright and attractive using "glitter" decals to give it a glitzy look. The game has been designed as a centerpiece game that will enhance the look of any location. Thick 16 gauge metal panels and marine grade water resistant plywood make the game extremely durable. The top of the cabinet is made of a special high impact styrene that is easy to maintain, and a thick acrylic dome that is extremely strong, and more scratch resistant than polycarbonate. Up higher, the glitter covered marquee flashes the wheel of fortune letters to attract game players. Brilliant backlighting of the playfield completes the look.



Electronics and sounds are the state of the art in digital technology. Robust design ensures a long trouble free life for your game. The game is very flexible with its programming options to allow it to be tailored to most locations easily. (For special non-standard options, call our service department for details).

GAME PLAY

The object of the game is to spin the wheel in the hope that it stops at the big bonus values.

To spin the wheel the player must stop the rotating light in the "Spin Zone".

This will automatically spin the wheel for the player. The wheel spin is totally random. As is where the wheel stops.



BEFORE YOU BEGIN

WARNING: WHEN INSTALLING THIS GAME, A GROUNDED A.C. RECEPTACLE MUST BE USED. FAILURE TO DO SO COULD RESULT IN INJURY TO YOURSELF OR OTHERS. FAILURE TO USE A GROUNDED RECEPTACLE COULD ALSO CAUSE IMPROPER GAME OPERATION, OR DAMAGE TO THE ELECTRONICS

DO NOT DEFEAT OR REMOVE THE GROUNDING PRONG ON THE POWER CORD FOR THE SAME REASON AS GIVEN ABOVE. USING AN IMPROPERLY GROUNDED GAME COULD VOID YOUR WARRANTY.

HAVE A QUALIFIED ELECTRICIAN CHECK YOUR A.C. RECEPTACLE TO BE SURE THE GROUND IS FUNCTIONING PROPERLY.

INSTALLATION

The game comes ready to play with just a few simple things to keep in mind.

1. When installing the game, be sure you use a grounded A.C. outlet. If necessary, have it checked to be sure the ground is good.

THIS GAME IS DESIGNED TO DISSIPATE STATIC ELECTRICITY THROUGH THE GROUNDING PLANE OF THE GAME. IF THE A.C. GROUND DOES NOT WORK, THE GAME COULD DISCHARGE STATIC ELECTRICITY THROUGH THE GAME CIRCUITRY, WHICH COULD CAUSE DAMAGE.

Make sure the game is level after installation. It is necessary to make sure the game is level so the game will work properly.

TOOLS YOU WILL NEED

The game normally comes fully assembled and ready for use.

If however, you need to disassemble or reassemble the marquee to the game for any reason, all that is needed is a Phillips screwdriver, 7/64" Allen wrench and a 7/16" socket and ratchet.

Place the game into its final location and use the adjusting feet to level the game. This is important to do, to assure proper operation of the game.

CAUTION: CHECK THAT THE A.C. VOLTAGE RATING ON THE BACK OF THE GAME MATCHES THE A.C. VOLTAGE OF YOUR LOCATION.

THE POWER SUPPLY IS NOT VOLTAGE ADJUSTABLE.

TO OPERATE THE GAME AT VOLTAGES OTHER THAN THOSE IT WAS DESIGNED FOR, PLEASE CONTACT OUR SERVICE DEPARTMENT FOR VOLTAGE CONVERSION INFORMATION.

Plug the game into the A.C. outlet and turn power to the game on. The switch for the game is located on a power module inside the game.

It is now time to program your game&&..

PROGRAMMING OPTIONS

INTRODUCTION

The Wheel of Fortune" game is extremely flexible from a programming standpoint. This allows the customer to "fine tune" the game to his or her exact needs.

This section will describe in detail each of the programming options and how they work.

PLEASE READ THIS SECTION THOROUGHLY BEFORE CALLING OUR SERVICE DEPARTMENT. MOST QUESTIONS REGARDING SET-UP AND OPERATION WILL BE FULLY EXPLAINED HERE.

HOW TO USE THE PROGRAMMING OPTIONS

PROGRAMMING BUTTON - Use this button to enter and exit the programming mode. Press this button once to enter the mode, and once again to exit the mode.

SELECT BUTTON - Use this button to scroll through and "step" through the various options.

CHANGE BUTTON - Use this button to "change" the value of a particular option.

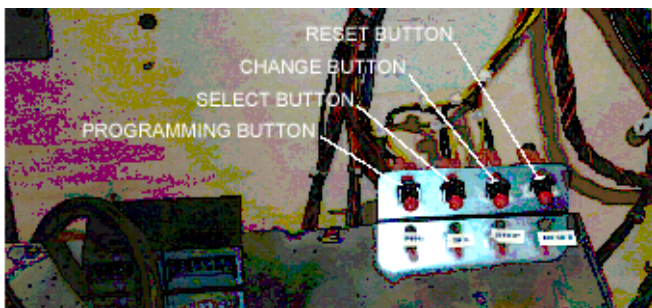

SETTING YOUR PAYOUT PERCENTAGE

The game has three basic adjustments to allow for percentaging the game properly. They are as follows:

LIGHT RING VALUES - These values can be changed through programming to allow for different ticket and game play values.

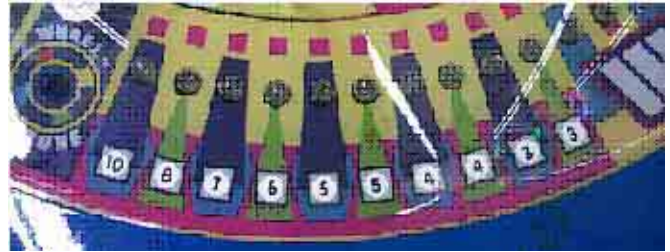

WHEEL JACKPOT VALUES - These can be changed through programming to allow for different ticket and game play values.

DIFFICULTY - This makes it easier or harder to hit the "spin zone" target. This will make the wheel spin less or more often. The wheel is set up with a difficulty of "6" from the factory. This allows the average player to spin the wheel about once every 20 times.

This setting is what we recommend you start with. It is important to keep it difficult enough to spin the wheel to keep the game interesting, but not so hard that it can't be done. It is important for bystanders to see that it is easy enough to do, so they will want to play as well.

CHANGING THIS SETTING IS THE EASIEST AND MOST EFFECTIVE WAY OF CHANGING YOUR PERCENTAGING.



PROGRAMMING OPTIONS

FORMULATING YOUR PERCENTAGES

The game comes from the factory based on a average 25 cent play, and a 1 cent retail ticket value, with a payback of 40%.

AT THE END OF THIS SECTION ARE SOME BASIC EXAMPLES OF PAYOUT COMBINATIONS AND THE FORMULA FOR TRYING YOUR OWN COMBINATIONS. IF YOU ARE UNABLE TO MAKE ANY OF THESE COMBINATIONS WORK FOR YOU, PLEASE CONTACT OUR SERVICE DEPARTMENT.

COINS PER CREDIT

(OPTION #1)

This option determines how many coins are needed to obtain 1 "credit". Setting a "0" puts the game into free play mode. The range for this option is 0-10. The default value for this option is "1".

GAMES PER CREDIT

(OPTION #2)

This option determines how many games or turns the player gets per credit. This option is useful if you have a minimum coin value that is so high you need to give the customer multiple games to get good value. The range for this option is 1-10. The default value for this option is "1".

CREDIT DISCOUNTING

(OPTION #3)

This determines the number of consecutive credits (without playing a game) given before dispensing a free game.

For example, if this option was set to "2", each time 2 coins IN A ROW were put in, a free game would be given.

The range for this option is 0-10. The default value for this option is "0".

VOLUME (OPTION #4)

This option determines the sound volume of the game. Setting a "0" turns the sound to minimum. Setting a "10"

ATTRACT TIME

(OPTION #5)

This option determines the duration of time between attract modes in minutes. The range for this option is 1-30. The default value for this option is "2".

ATTRACT MODE TYPE

(OPTION #6)

This option determines what type of attract mode (if any) is used. Setting a "0" turns the attract mode off. Setting a "1" makes sound only. Setting a "2" spins the wheel only. Setting a "3" gives both sound and the wheel spin. The default value for this option is "3"

JUST FOR SPINNING TICKETS

(OPTION #7)

Enabling this option will give the player a predetermined amount of extra or "bonus" tickets before the wheel is spun. The tickets will begin to pay out as the wheel begins to spin. The range for this option is 0-50. Setting a "0" turns this option OFF. The default value of this option is "0".

PROGRAMMING OPTIONS

ZONE VALUES (OPTIONS #8-27)

The ring light values can be adjusted through programming and by changing the decals on the playfield itself.

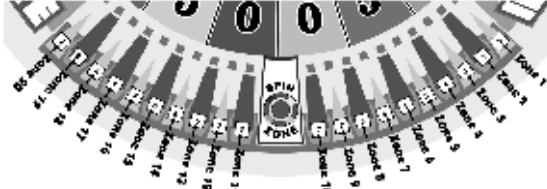

This determines the ring light values for zones 1-20. Each zone can be set to pay out 0-20 tickets. The chart below will give you the default values for each zone, as well as translate the option number to the zone. Please see the chart above to realize the proper relationship between zone, option number, and position on the playfield. Example, Zone 10 is to the immediate right of the "spin zone" and is option #16.

OPTION#	ZONE#	DEFAULT
8	1	3
9	2	3
10	3	4
11	4	4
12	5	5
13	6	5
14	7	6
15	8	7
16	9	8
17	10	10
18	11	10
19	12	8
20	13	7
21	14	6
22	15	5
23	16	5
24	17	4
25	18	4
26	19	3
27	20	3

WHEEL JACKPOT VALUES

The jackpot values can be adjusted through programming and by changing the decals themselves. This helps to adjust for differing game play and ticket values

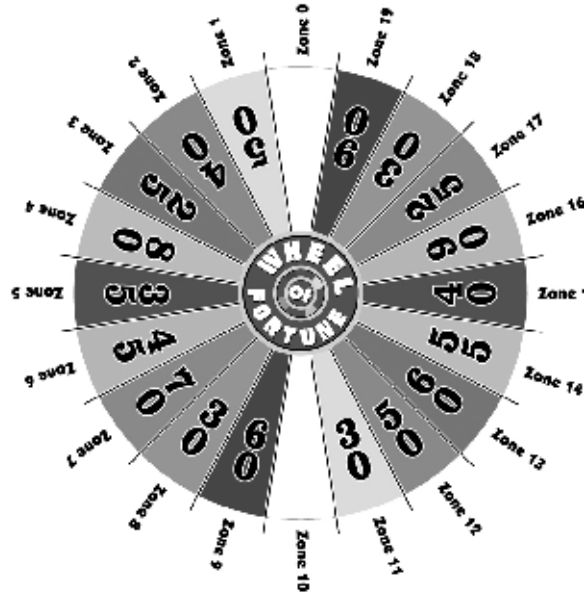

NON-HOME JACKPOT VALUE, ZONE 10 (OPTION #28)

This is the white jackpot wedge BELOW the words Wheel of Fortune on the center hub of the wheel. The numbers are removable and can be replaced with the other values supplied with the game.

The range for this option is 0-1000. The default value for this option is "300"

HOME JACKPOT VALUE ZONE 0 (OPTION #29)

This is the white jackpot wedge ABOVE the words Wheel of Fortune on the center hub of the wheel. The numbers are removable and can be replaced with the other values supplied with the game.

The range for this option is 0-1000. The default value for this option is "500"

PROGRAMMING OPTIONS

BIG JACKPOT LOCKUP (OPTION #30)

This option will allow the game to “Lock up” when either of the jackpot wedges are hit. This allows the location to save on tickets if the jackpot wedges are set to pay out a high amount. To clear the lock up, open the coin door and hit the “Ticket Reset” button on the cash box enclosure. The range for this option is 0–1. Setting a “1” turns this feature ON. The default value for this option is “0” (off).

WHEEL DIFFICULTY (OPTION #31)

this option determines how hard it is to stop the light in the “Spin Zone”. This adjusts the size of the “time window” to make it easier or harder. The numbers available represent MILLISECONDS (1/1000th of a second).

The range for this option is 1–20. The default value for this option is “6”.

When the game is set to “6”, average players will hit the spin zone approximately once every 20 times. This is where we feel the game works best, balancing difficulty with the excitement of being able to hit the target on a consistent basis.

CHANGE THIS SETTING TO RASIE OR LOWER THE PAYBACK PERCENTAGE.

In the event that the wheel difficulty needs to be changed, please use the chart below to give you a rough idea of how your changes will affect game play. These numbers will vary according to the age group and skill of your customers.

MILLISECONDS 1 IN XXXXXX HITS

1	1 IN 300
2	1 IN 120
3	1 IN 60
4	1 IN 45
5	1 IN 30
6	1 IN 20 (DEF)
7	1 IN 10
8	1 IN 5

WINABILITY (OPTION #32)

If you wish to keep your percentages more accurate, or have some especially talented players that always win easily, you may want to use this option.

What win ability does is this. You set the “wheel difficulty” option to a number that is harder to win such as “3” (a one in 60 hit average). You then set this option to “20”. This means that after 20 games are played, the difficulty window will open to full open making it much easier to win. This way you’ll get a winner about every 20 games or so, but the more talented player would have to be much better to win. Since this still works based solely on skill, it remains fair and winnable for the advanced player, but will get easier to allow less skillful people to win as well.

The range for this option is 0–100. Setting a “0” turns this option OFF. The default value for this option is “0”.

COUNTER TYPE (OPTION #33)

This option determines how the money counters work in the game. Setting a “0” has the counters work so that each time a COIN is inserted the counter will increment 1. Setting a “1” has the counter work that each time a CREDIT (one OR MORE coins) is inserted and earned, the counter will increment by 1. The default setting for this option is “0” (Advances once for each coin inserted).

SOUND LOOP (OPTION #34)

This option will loop a money payout sound and lock up the game until all tickets have been dispensed IN THE EVENT OF A JACKPOT. This can add extra excitement to the game. The range for this option is 0–1. Setting a “1” turns this option on. The default value for this option is “0”, OFF.

PROGRAMMING OPTIONS

FACTORY RESET (OPTION #35)

This option is used to GLOBALLY RE-SET all of the software settings to the FACTORY DEFAULT. Setting a "1" will re-set all of the settings to their factory default as when you first received the game. The default value for this option is "0" (NO RE-SET).

**IF YOU HAVE ANY QUESTIONS OR
COMMENTS, PLEASE CONTACT OUR
SERVICE DEPARTMENT AT:**

716-759-0360

MON. THRU FRI. 8AM-6PM EST

GAME SETTING EXAMPLES

The examples shown below are intended to act as a guide when setting up your game. Please be advised these are generalities and your game in all likelihood will need to be adjusted for your particular clientele.

25-cent play - 1-cent ticket
(spin zone) 7-6-6-5-5-4-4-3-3-2
Jackpot 500 - 300
6 MS Difficulty setting (average 1 in 20 spins)

80-cent play - 5-cent ticket
(spin zone) 5-4-3-2-2-2-2-2-1-1
Jackpot 500 - 300
6 MS Difficulty setting (average 1 in 20 spins)

50-cent play - 1-cent ticket
(spin zone) 10-10-9-9-8-8-7-7-7-7
Jackpot 900 - 900
7 MS Difficulty setting (average 1 in 15 spins)

5-cent play - 1-cent ticket
(spin zone) 2-1-0-0-0-0-0-0-0-0
Jackpot Bankrupt - Bankrupt
5 MS Difficulty setting (average 1 in 30 spins)

PAYOUT CALCULATION FORMULA

If you would like to try to figure out your own payout calculations, please use the formula on the next page.

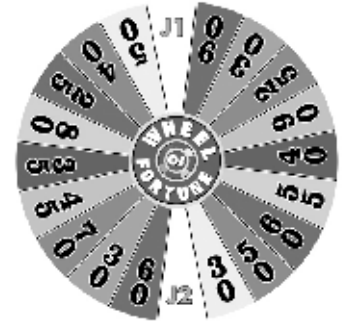
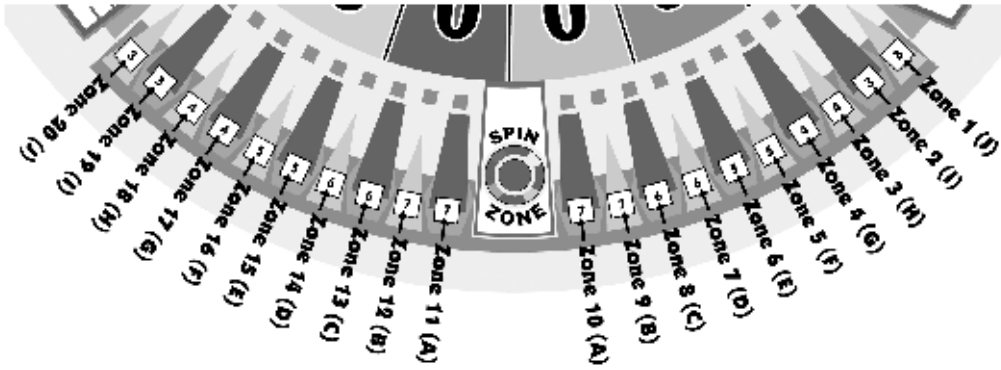

Total Wheel Value

$$= 905 + J1 + J2$$

$$\left[\left(\frac{[A+B+C+D] + \left[\frac{E+F+G+H+I+J}{6} \right]}{5} \right) (y) \right] + \left[\frac{905+J1+J2}{20} \right]$$

20

1. Assign Ticket Values to A–J, y (normally 19), and Jackpot 1 (J1; normally 300) and Jackpot 2 (J2; normally 500)
 2. Add up values of A–D
 3. Add up values of E–J and Divide by 6
 4. Add the number you get in Step 2 to the number you get in Step 3
 5. Take the number you get in Step 4 and divide it by 5
 6. Take the number you get in Step 5 and multiply it by (y)
 7. Add 905, J1 and J2 and divide that number by 20
- Add the number you get from Step 6 and Step 7 together and divide that number by 20

***** This calculation assumes that the values on both sides of the spin zone are set the same. If you set the 2 sides different, run this calculation for both sides and average.**

MAINTENANCE

GENERAL MAINTENANCE

This game has been designed to be as trouble and maintenance free as possible.

With this in mind the only basics are to keep the game clean. Below are the main areas to take care of with specific directions.

DOME

The dome should be cleaned with a soapy water solution if covered with water based dirt such as food products. After cleaning with soapy water, polish with a commercial plastic polish or a spray furniture polish. These have lubricating oils that condition the plastic and keep it shiny and clear looking. Never use regular glass cleaners as the ammonia in them actually damages the plastic and dulls it.

Any deep scratches can be reduced or eliminated with a scratch removing polish and buffing wheel.

CABINET

The cabinet plastic and decals can be cleaned with soapy water or spray furniture polish. DO NOT use any alcohol or petroleum based cleaners as they could damage the plastic or printed parts.

COIN MECHANISMS

The coin mechanisms should be cleaned periodically, as they will accumulate dirt which will cause the coins to stick.

Remove the coin mech and clean them in a dish detergent solution and a stiff brush. Dry thoroughly and re-install.

TICKET DISPENSERS

The biggest problem ticket dispensers have is ticket dust blocking the optical detectors. It is a good idea to occasionally use compressed air to remove the dust from the dispensers.

QUICK TROUBLESHOOTING

GAME WILL NOT TAKE OR ADD MONEY CORRECTLY

- **Micro switch not working or returning properly. Check and repair or replace as necessary.**
- Bad Harnessing or connector. Check w/ohm meter and repair as necessary.
- Game programming set incorrectly. Check programming option and re-program if necessary.
- Bad Main P.C. Board. Check and repair or replace as necessary.

STOP BUTTON WILL NOT FLASH WHEN GAME HAS CREDITS, OR WORK WHEN PUSHED

- Micro switch not working properly. Test and replace as necessary.
- Micro switch popped out of housing. Snap back into housing.
- Burned out light bulb. Replace light bulb.
- Bad harnessing or connector. Check w/ohm meter and repair as necessary.
- Bad Main P.C. Board. Check and repair or replace as necessary.

GAME HAS NO SOUND

- Bad speaker. Check w/ohm meter for 4 or 8-ohm load. If not within this range, replace.
- Volume level set incorrectly. Check volume level in programming, and adjust if necessary.
- Bad Harnessing or connector. Check w/ohm meter and repair as necessary.
- Bad Main P.C. Board. Check and repair or replace as necessary

TICKET DISPENSER DOES NOT WORK OR WORKS IMPROPERLY

- Bad ticket dispenser. Repair or replace as necessary.
- Bad harnessing or connector. Check w/ohm meter and repair as necessary.
- Bad Main P.C. Board. Check and repair or replace as necessary.
- Game out of tickets. Add tickets
- Optical sensor on ticket dispenser dirty. Remove paper fuzz and debris with a soft brush.

NO FLORESCENT LIGHTING

- Bulb burned out. Replace bulb.
- Electronic ballast bad. Replace ballast.
- Harness bad or harness unplugged. Check w/ohm meter and plug in, repair or replace as necessary.
- No A.C. power to the game or Main fuse bad. Check fuse and A.C. power.

ALARM SOUND DOES NOT WORK OR FALSE TRIGGERS (OPTIONAL)

- Bad Main P.C. Board. Check and repair or replace as necessary
- Bad Harnessing. Check w/ohm meter and repair or replace as necessary.
- Alarm Plum bob set up improperly. Check for proper plum bob clearance and adjust as necessary.
- Game not level. Level game to be sure plum bob is operating correctly.
- Game unplugged. Plug game back in and test for proper operation.

WHEEL WILL NOT SPIN OR SPINS SLOWLY

- Bad Motor. Check or replace as necessary
- Bad harnessing. Check and repair as necessary
- Bad motor cooling fan causing overheating of motor. Replace fan.
- Clicker solenoid not disengaging properly. Check and replace solenoid if necessary.
- Clicker return spring. Check and replace spring if necessary.

QUICK TROUBLESHOOTING

LIGHT RING DOES NOT LIGHT

- Bad Main P.C. Board. Fix or replace main board.
- Bad light ring board. Find problem board and replace or repair as necessary.
- Bad light ring board harnessing. Repair as necessary.
- Blown fuse on Main P.C. Board. Replace fuse. Check for problems.

MARQUEE DOES NOT LIGHT

- Fuse blown on main P.C. Board. Replace fuse.
- Harnessing between marquee and main board bad. Check and repair as necessary.
- Bad Marquee P.C. Board. Repair or replace as necessary.

CREDITS OR TICKETS OWED DISPLAYS DON'T WORK PROPERLY

- Bad Display P.C. Board. Repair or replace Display board
- Bad Main P.C. Board. Repair or replace Main board.
- Bad display harnessing. Repair as necessary.

CAN'T ENTER OR EXIT PROGRAMMING OR OTHER ADJUSTMENT MODES

- Bad programming or adjustment buttons. Replace buttons. Check harnessing.
- Harnessing fell off back of button. Re-attach harnessing.
- Bad Main P.C. Board. Repair or replace Main board.

GAME REPAIR

WARNING: ALWAYS REMOVE POWER TO THE GAME BEFORE ATTEMPTING ANY SERVICE, UNLESS NEEDED FOR SPECIFIC TESTING.

FAILURE TO OBSERVE THIS PRECAUTION COULD RESULT IN SERIOUS INJURY TO YOURSELF OR OTHERS.

OPERATIONAL BACKGROUND

The "Wheel of Fortune" game has been manufactured with modular design in mind. Almost everything in the game can be EASILY removed for servicing. This makes it much easier for the repairman as he /she can work in a quieter less distracting environment away from the Game Room floor. The game relies on 1 brushed DC for the mechanical spinning of the wheel. This motor can be accessed easily for service.

Coin and low ticket sensing are done with conventional micro switches. In all areas of critical importance, optical sensors were developed specifically, and optimized for their particular application.

All P.C. Boards are made of premium quality board material and use time proven components to assure you of the most reliable designs possible.

We have put forth our best efforts and tested this game extensively to assure the best possible performance under the widest variety of operating conditions. We are ALWAYS however interested in our customers input for product improvement. If you have any questions or comments please feel free to contact our service department.

I.C.E. SERVICE DEPARTMENT

716-759-0360

NORMAL BUSINESS HOURS ARE:

MONDAY - FRIDAY, 8:00 AM TO 5:00 PM

TROUBLESHOOTING PHILOSOPHY

To find problems with the game, always first check what should be obvious. See that the game is plugged in, and that all of the fuses on the game are good. This includes the fuse that is located INSIDE the power module.

Next, check to see that all of the connectors are firmly seated and that none of the wires have been pulled out of them.

When trying to find out if specific components are bad or not, try swapping them with components from another player station to see if the problem moves with the component, or stays where it was. This will help you to know if you have a problem with a specific component, or maybe a problem with either the wiring or the Main P.C. Board.

Use extreme caution when using probes or voltmeters if the game is powered up. If doing continuity checks, it is important to disconnect the harnessing at both ends, as attached they may yield erroneous results.

If a P.C. Board is suspected as the cause of a problem, check to see that all of the components on the board are firmly attached. Pay special attention to any socketed devices.

If light bulbs are suspected, swap them with one that is known to work to narrow the problem down to either a bulb or P.C. Board.

GAME REPAIR

REPLACEMENT & REPAIR

LIGHT RING SERVICING

Service the light ring as follows:

Remove the Allen bolts that hold the cover on to the cabinet.



Lift the cover up and remove the dome. (See dome replacement instructions)

Remove the 2 wheel clickers by unscrewing them.



Remove the Light Ring graphics by lifting the ring up.



Remove the plastic spacers that hold the board in place.

Remove the connector to the board.



Assemble in the reverse order.

MOTOR SERVICING / REPLACEMENT

Service the motor as follows:

Remove the Allen bolts that hold the cover on to the cabinet.



GAME REPAIR

Lift the cover up and remove the dome. (See dome replacement instructions)

Remove the wheel by unscrewing the 3 screws that hold it in place.



Remove the motor by unscrewing the screws that hold it in place.



Disconnect the plug on the motor from the motor harness.

Assemble in reverse order.

MARQUEE BULB / P.C. BOARD SERVICE

To replace a light bulb or remove the P.C. Board follow the directions below.

Remove the Phillips head screws that hold the marquee cover in place.



Remove the bolts that hold the inside wood housing together.

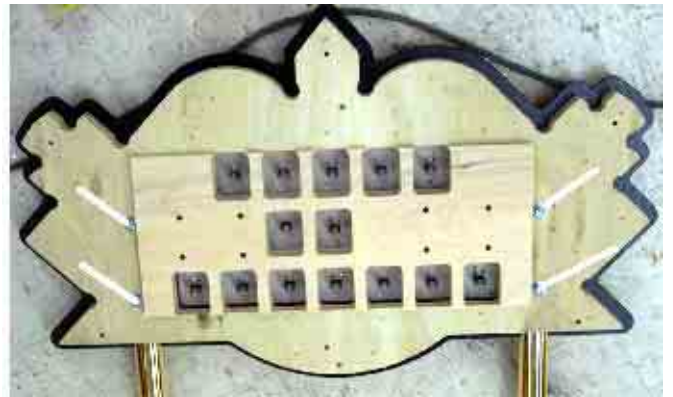

Remove the main p.c. board by removing the screws and connector that hold it in place.

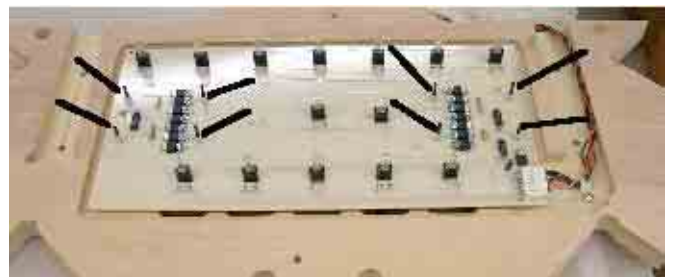

Reassemble in reverse order.

GAME REPAIR

CREDITS / TICKETS OWED P.C. BOARD SERVICE

Remove the Allen bolts that hold the cover on to the cabinet.



Lift the cover up to access the Display P.C. Boards.



Unscrew and remove the boards for service.

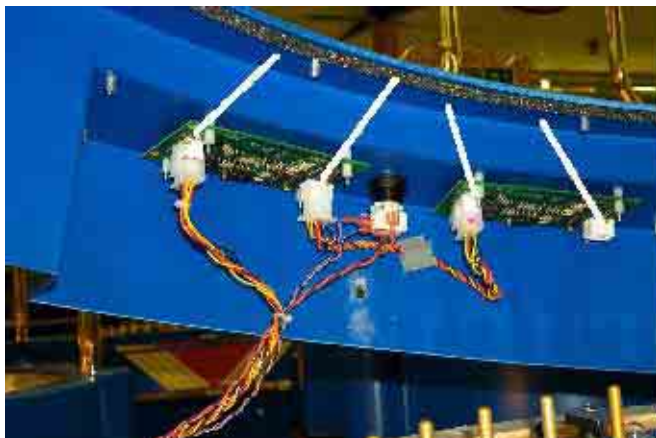

Reassemble in reverse order.

DOMES REPLACEMENT

Remove the Allen head bolts that hold the cover to the cabinet.



Lift up the cover and remove the Dome. Set the new dome onto the playfield centered evenly in the game.



Lower the cover and bolt into place.

IF YOU HAVE ANY QUESTIONS OR COMMENTS, PLEASE CONTACT OUR SERVICE DEPARTMENT AT:

716-759-0360

MON. THRU FRI. 8AM-6PM EST

PARTS LISTINGS

Parts denoted with * indicate available as part of a specially discounted spares kit.

MECHANICAL PARTS

211	Low Ticket Micro Switch
BW250X	PLL Bulb Socket Assembly
FP1004	Leg Leveler Mounting Bracket
HR1019	Leveler Foot
1024	Ticket Bin
1026	Bracket, Low Ticket Switch Mounting
WF1050	Clicker Pole, Teflon coated
CP1051	Tilt Sensor
WF1051	Wheel Hub
WF1052	Wheel Pin, 1"
WF1053	Wheel Pin, 1.5"
WF1054	Wheel Pin, 2"
WF1055	Wheel Pin, non extension
WF1056	Flag, Opto beam breaker
WF1060*	Clicker Spring
CG1068	Bushing, bronze oil impregnated
HR2005	Large round white push button
AR2007	Speaker, 6" x 9"
BW2017	PLL Bulb Retaining Clip
BW2018	PLL Bulb Support
2027	Fan, DC 12 Volt
CC2027	Power Cord, 20ft.
HH2050	Power Module
2364G	Fan Guard
WF3001	Cabinet Cover
WF3004*	Clicker (pointer)
WF3005	Marquee Housing
WF3024X	Dome Assembly, with tape
HH5005	Ticket Dispenser
5101X	Mech Holder Assembly
WF6001X*	Parts Package
6321	3/8" E-Clip
BW8284X	Workhorse 6 Ballast, (WH6-120-L)
8312*	Bulb, PL-L 40W/41/RS/IS Florescent
WF9010	Cover, clicker sensor (black card)

ELECTRONIC / ELECTRICAL

WF2002X	Transformer
2005*	906 Light Bulb
2008*	Solenoid, Spring Tensioner
PP2011X*	Wheel Motor, D.C.
WF2034X	Main P.C. Board
WF2037X*	Marquee P.C. Board
WF2038X*	Clicker Position P.C. Board., Large
WF2039X*	Clicker Position P.C. Board, Small
WF2040X*	Wheel Position P.C. Board, Outer
WF2041X*	Wheel Position P.C. Board, Inner
2110	TIP 122 Transistor
2117	IC, 74hc14
2305	IC, 74hc273
CC2032X*	Tickets Owed Display P.C. Board
CC2035X*	Light ring board (banana board)
2295	Fuse, MDQ6 (6 amp slo blo)
2315	Fuse, MDQ3 (3 amp slo blo)

DECALS AND GRAPHICS

WF7001	Side Panel Decal
WF7002	Center Wheel (sold w / WF7013)
WF7004	Podium Side Decal
WF7005	Instruction Plate Decal
WF7006	Ticket Arrow Decal
WF7013	Outer Ring (sold w / WF7002)
WF7014	Clicker overlay glitter decal
WF7015	Monaco Logo Decal
WF7027	Marquee Panel
WF9001	Service Manual

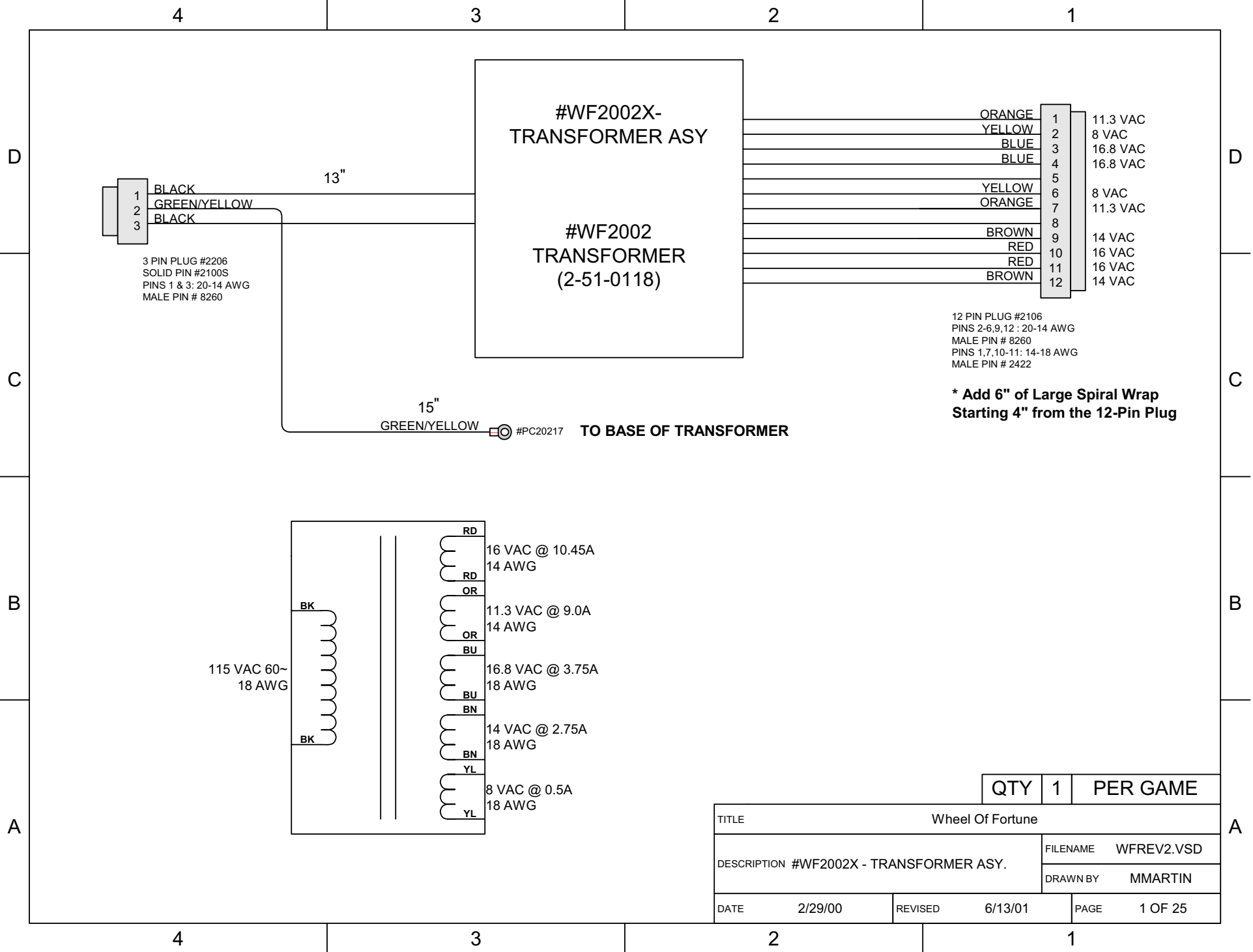

TITLE		Wheel Of Fortune	
DESCRIPTION		FILENAME	WFREV2.VSD
		DRAWN BY	MMARTIN
DATE	2/29/00	REVISED	6/13/01
		PAGE	1 OF 25

QTY	1	PER GAME
-----	---	----------

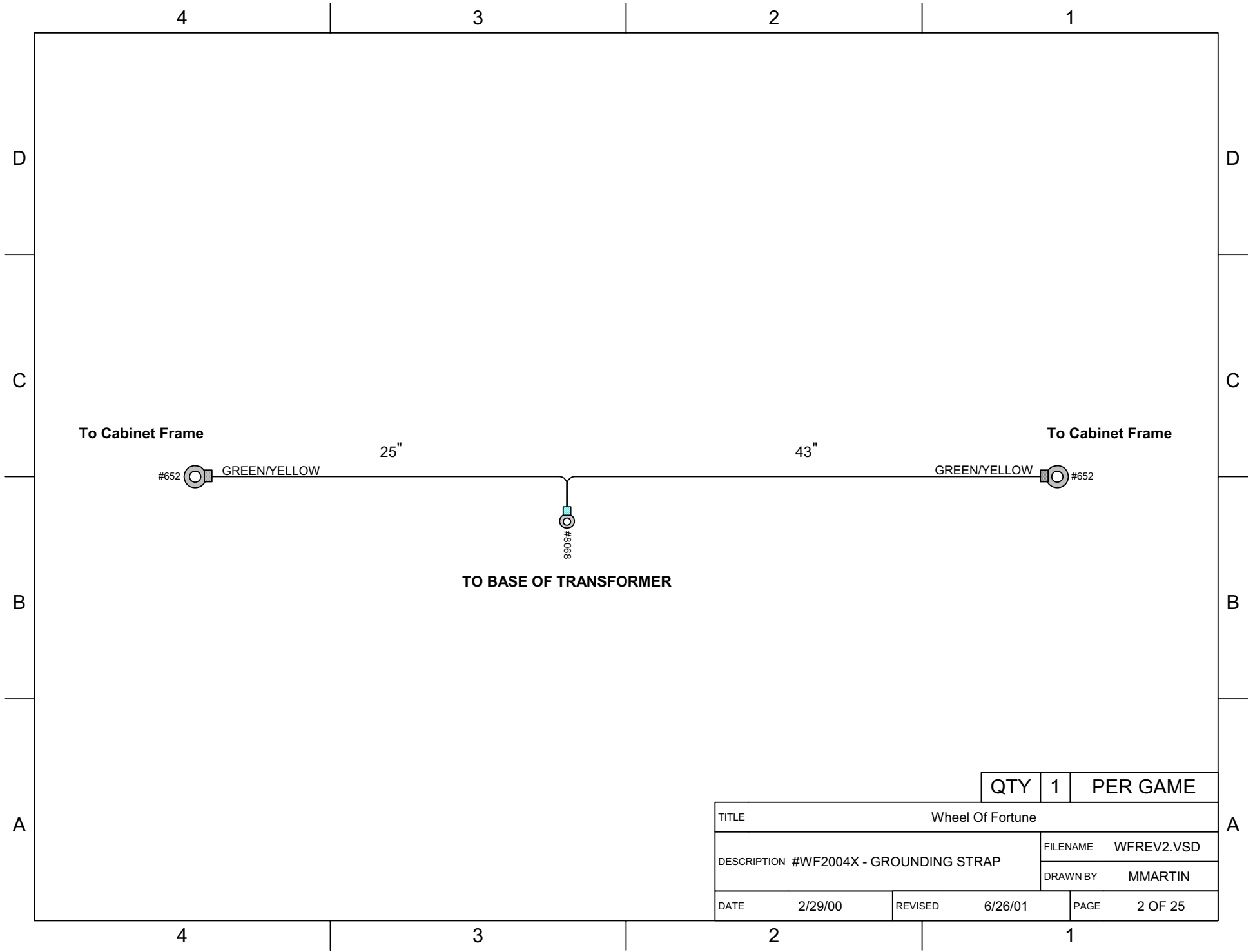

		QTY	1	PER GAME
TITLE Wheel Of Fortune				
DESCRIPTION #WF2004X - GROUNDING STRAP			FILENAME	WFREV2.VSD
			DRAWN BY	MMARTIN
DATE	2/29/00	REVISED	6/26/01	PAGE 2 OF 25

4

3

2

1

D

D

C

C

B

B

A

A

To Wheel Motor
Harness

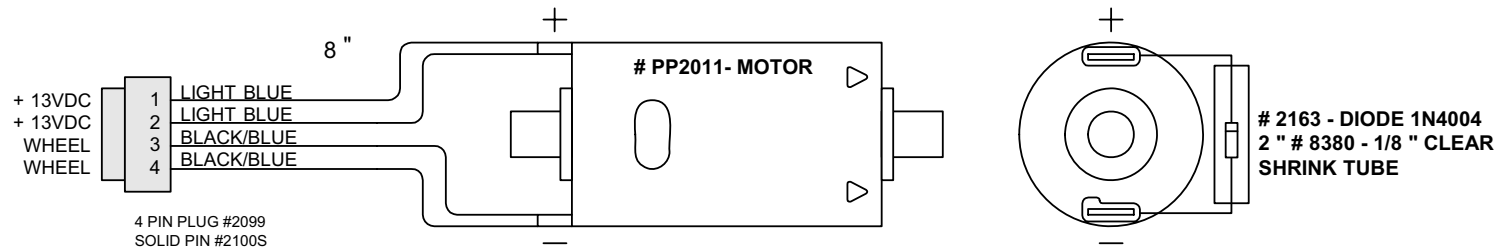

QTY	1	PER GAME
-----	---	----------

TITLE		Wheel Of Fortune	
DESCRIPTION	# WF2008X - WHEEL MOTOR ASSEMBLY		FILENAME WFREV2.VSD
			DRAWN BY MMARTIN
DATE	2/29/00	REVISED	5/3/01
		PAGE	3 OF 25

4

3

2

1

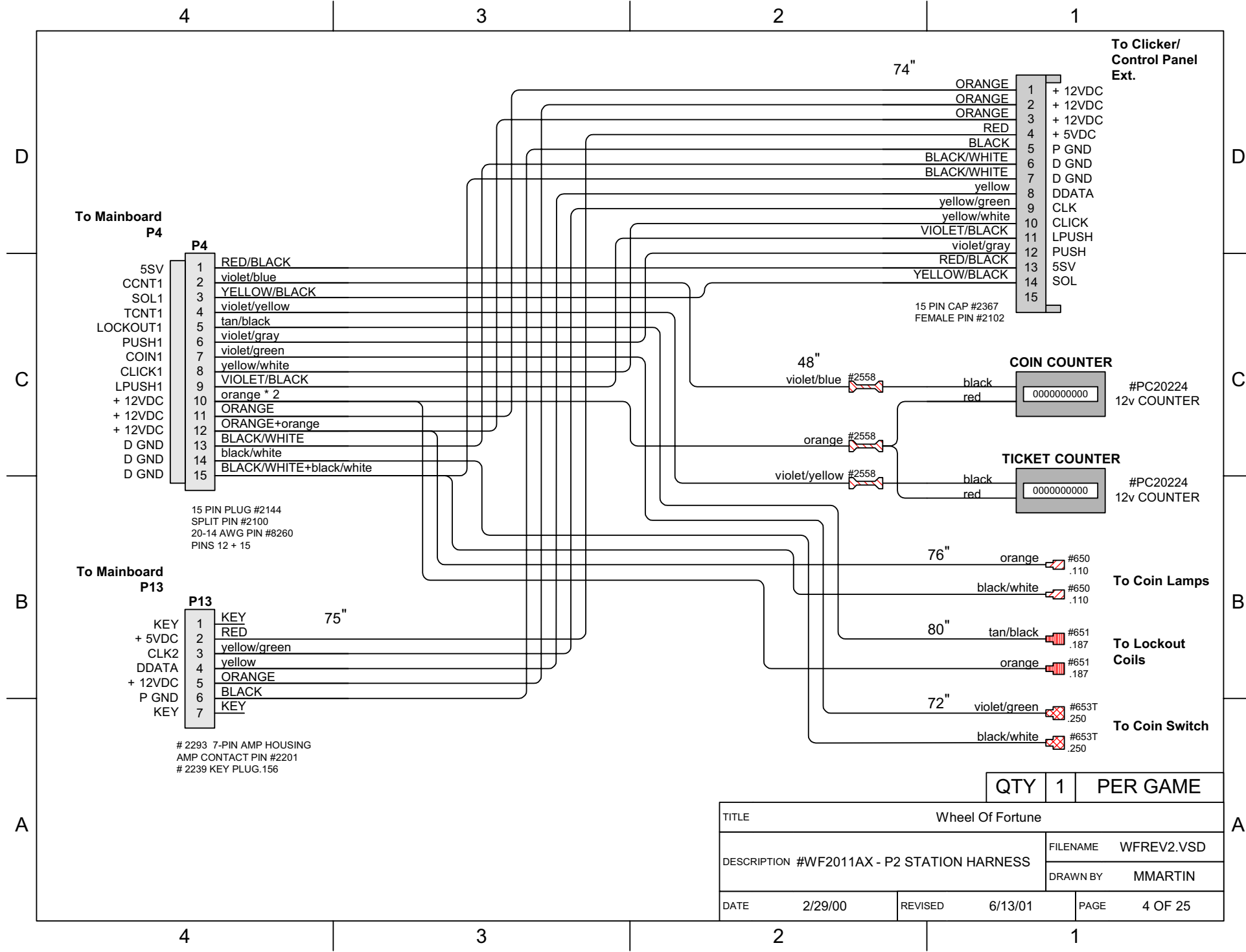

QTY	1	PER GAME
-----	---	----------

TITLE		Wheel Of Fortune	
DESCRIPTION		FILENAME	WFREV2.VSD
		DRAWN BY	MMARTIN
DATE	2/29/00	REVISED	6/13/01
		PAGE	4 OF 25

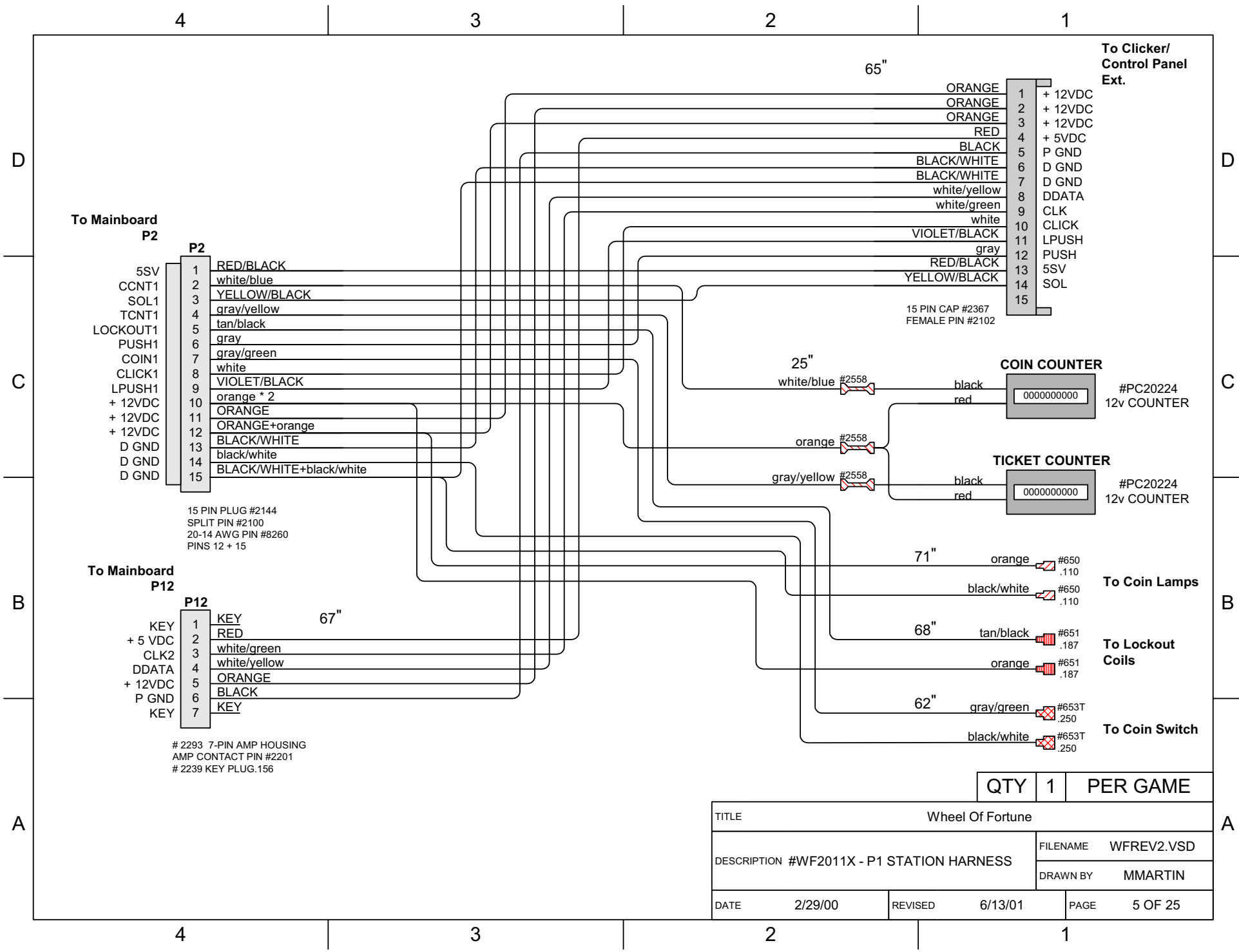

To Mainboard
P2

- 5SV
- CCNT1
- SOL1
- TCNT1
- LOCKOUT1
- PUSH1
- COIN1
- CLICK1
- LPUSH1
- + 12VDC
- + 12VDC
- + 12VDC
- D GND
- D GND
- D GND

- | P2 | Color |
|----|-------------------------|
| 1 | RED/BLACK |
| 2 | white/blue |
| 3 | YELLOW/BLACK |
| 4 | gray/yellow |
| 5 | tan/black |
| 6 | gray |
| 7 | gray/green |
| 8 | white |
| 9 | VIOLET/BLACK |
| 10 | orange * 2 |
| 11 | ORANGE |
| 12 | ORANGE+orange |
| 13 | BLACK/WHITE |
| 14 | black/white |
| 15 | BLACK/WHITE+black/white |

15 PIN PLUG #2144
SPLIT PIN #2100
20-14 AWG PIN #8260
PINS 12 + 15

To Mainboard
P12

- | P12 | Color |
|-----|--------------|
| 1 | KEY |
| 2 | RED |
| 3 | white/green |
| 4 | white/yellow |
| 5 | ORANGE |
| 6 | BLACK |
| 7 | KEY |

2293 7-PIN AMP HOUSING
AMP CONTACT PIN #2201
2239 KEY PLUG.156

To Clicker/
Control Panel
Ext.

- | Color | Signal |
|-------|---------|
| 1 | + 12VDC |
| 2 | + 12VDC |
| 3 | + 12VDC |
| 4 | + 5VDC |
| 5 | P GND |
| 6 | D GND |
| 7 | D GND |
| 8 | DDATA |
| 9 | CLK |
| 10 | CLICK |
| 11 | LPUSH |
| 12 | PUSH |
| 13 | 5SV |
| 14 | SOL |
| 15 | |

COIN COUNTER

#PC20224
12v COUNTER

TICKET COUNTER

#PC20224
12v COUNTER

To Coin Lamps

To Lockout
Coils

To Coin Switch

QTY	1	PER GAME
-----	---	----------

TITLE		Wheel Of Fortune	
DESCRIPTION		FILENAME	WFREV2.VSD
		DRAWN BY	MMARTIN
DATE	2/29/00	REVISED	6/13/01
		PAGE	5 OF 25

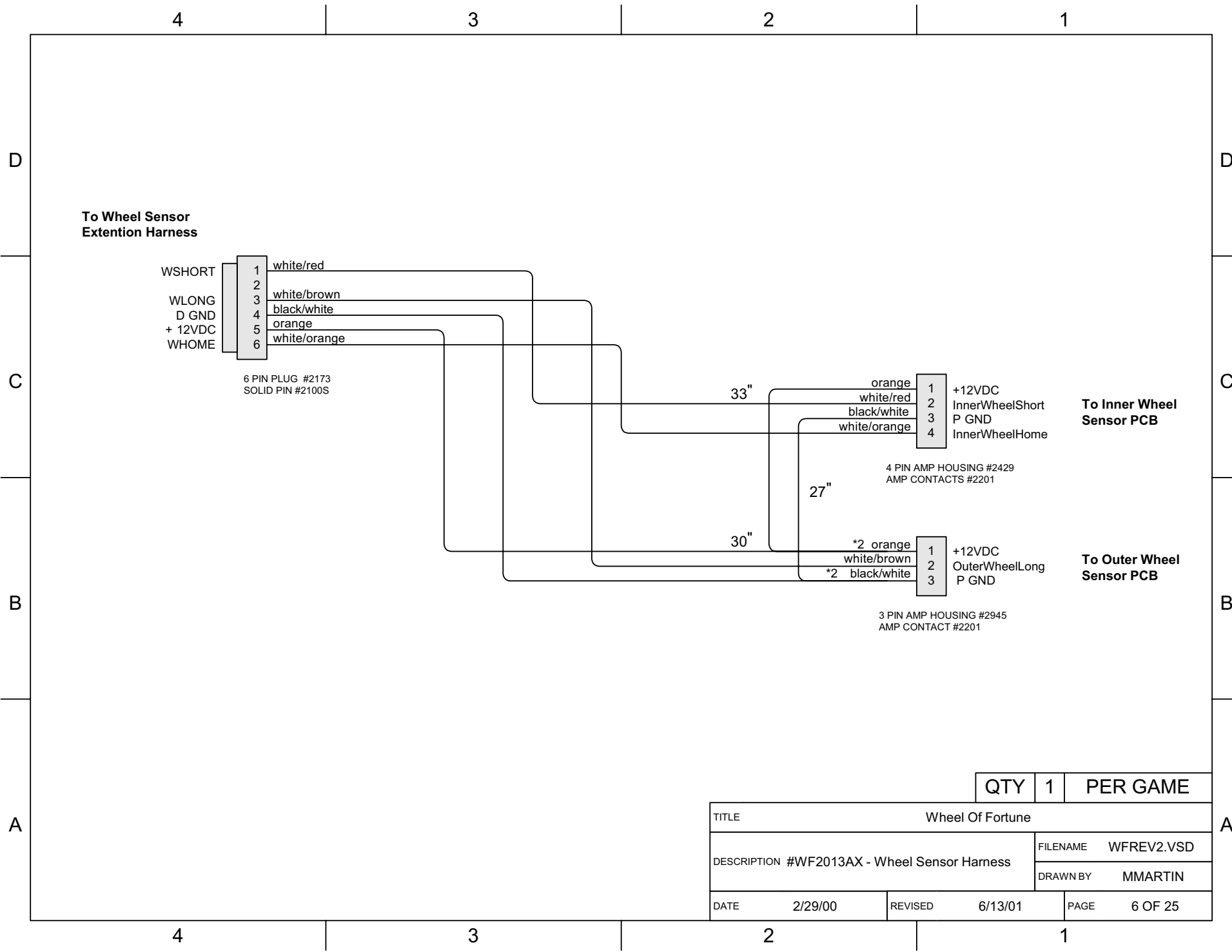

QTY	1	PER GAME
-----	---	----------

TITLE		Wheel Of Fortune	
DESCRIPTION		FILENAME	WFREV2.VSD
		DRAWN BY	MMARTIN
DATE	2/29/00	REVISED	6/13/01
		PAGE	6 OF 25

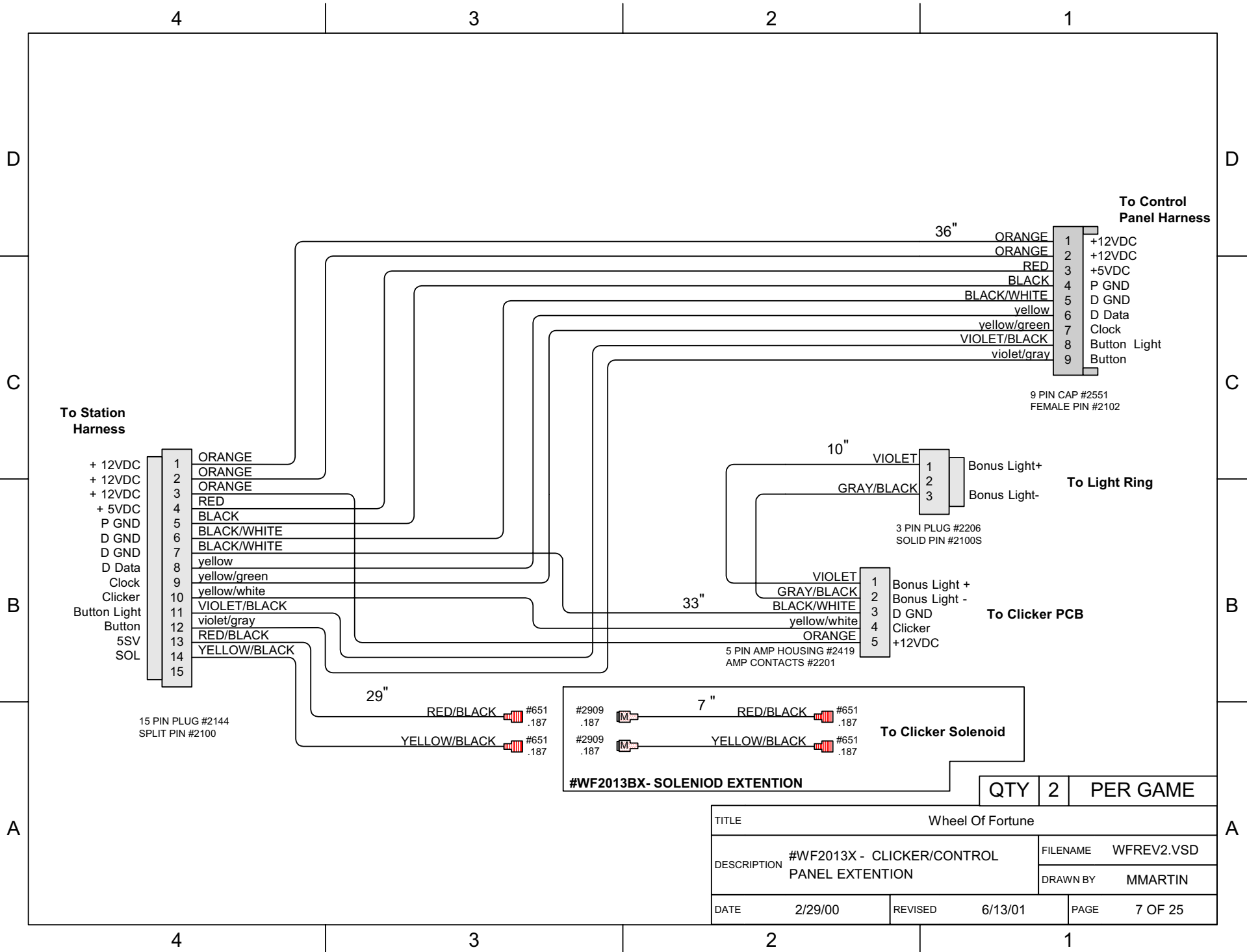

To Station
Harness

- + 12VDC
- + 12VDC
- + 12VDC
- + 5VDC
- P GND
- D GND
- D GND
- D Data
- Clock
- Clicker
- Button Light
- Button
- 5SV
- SOL

- 1 ORANGE
- 2 ORANGE
- 3 ORANGE
- 4 RED
- 5 BLACK
- 6 BLACK/WHITE
- 7 BLACK/WHITE
- 8 yellow
- 9 yellow/green
- 10 yellow/white
- 11 VIOLET/BLACK
- 12 violet/gray
- 13 RED/BLACK
- 14 YELLOW/BLACK
- 15

15 PIN PLUG #2144
SPLIT PIN #2100

To Control
Panel Harness

- 36" 1 ORANGE
- 2 ORANGE
- 3 RED
- 4 BLACK
- 5 BLACK/WHITE
- 6 yellow
- 7 yellow/green
- 8 VIOLET/BLACK
- 9 violet/gray

9 PIN CAP #2551
FEMALE PIN #2102

To Light Ring

- 10" 1 VIOLET
- 2 GRAY/BLACK
- 3

3 PIN PLUG #2206
SOLID PIN #2100S

To Clicker PCB

- 33" 1 VIOLET
- 2 GRAY/BLACK
- 3 BLACK/WHITE
- 4 yellow/white
- 5 ORANGE

5 PIN AMP HOUSING #2419
AMP CONTACTS #2201

To Clicker Solenoid

- 7" #2909 .187 RED/BLACK #651 .187
- #2909 .187 YELLOW/BLACK #651 .187

#WF2013BX- SOLENIOD EXTENTION

QTY 2 PER GAME

TITLE				Wheel Of Fortune			
DESCRIPTION		#WF2013X - CLICKER/CONTROL PANEL EXTENTION		FILENAME	WFREV2.VSD		
DATE		2/29/00	REVISED	6/13/01	PAGE	7 OF 25	
					DRAWN BY MMARTIN		

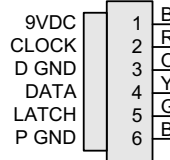
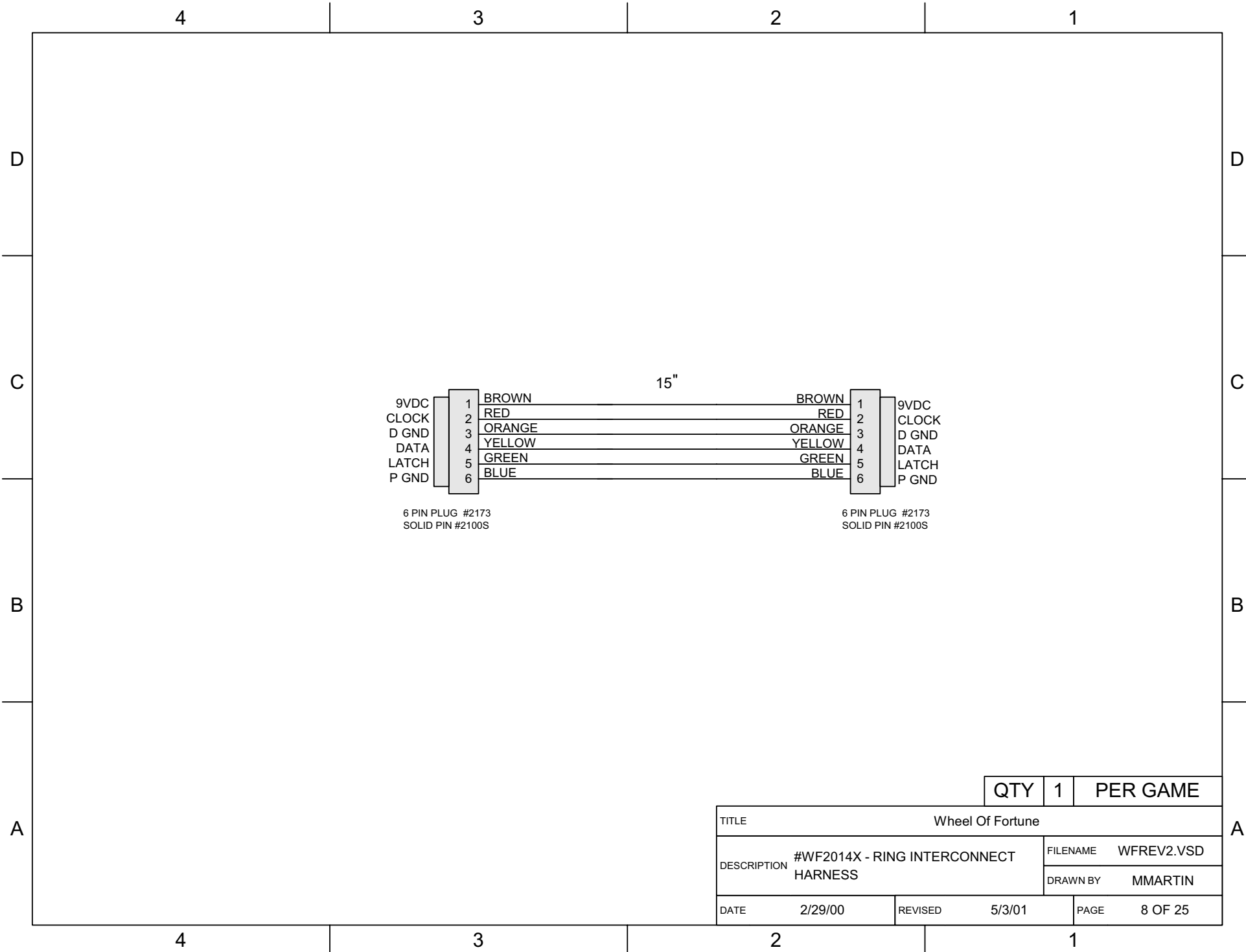

6 PIN PLUG #2173
SOLID PIN #2100S

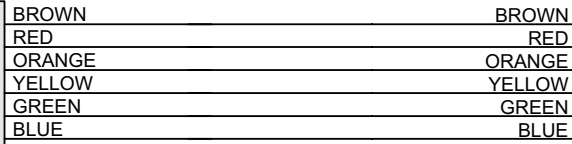

15"

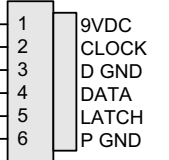

6 PIN PLUG #2173
SOLID PIN #2100S

QTY	1	PER GAME
-----	---	----------

TITLE		Wheel Of Fortune			
DESCRIPTION	#WF2014X - RING INTERCONNECT		FILENAME	WFREV2.VSD	
	HARNESS		DRAWN BY	MMARTIN	
DATE	2/29/00	REVISED	5/3/01	PAGE	8 OF 25

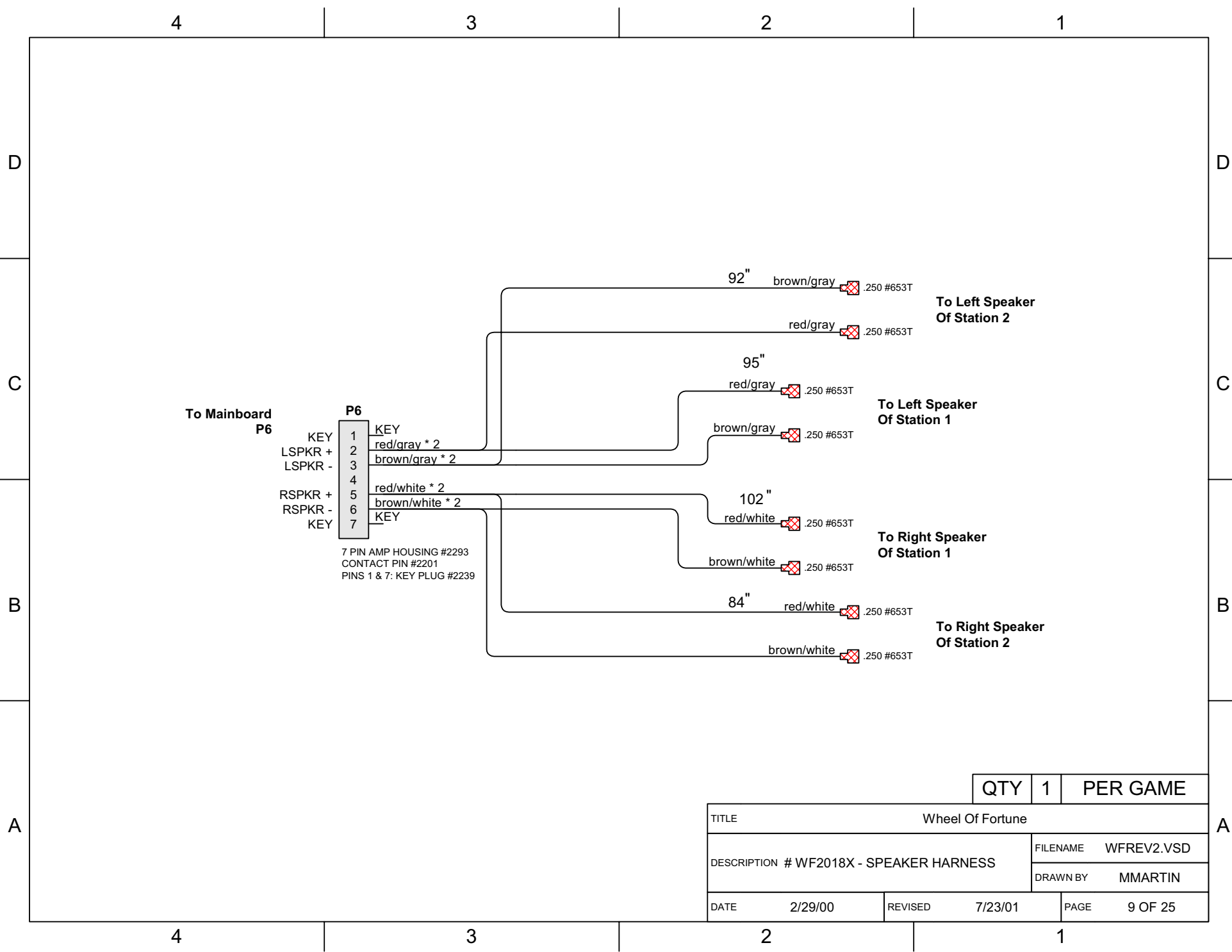

To Mainboard
P6

P6	
1	KEY
2	red/gray * 2
3	brown/gray * 2
4	
5	red/white * 2
6	brown/white * 2
7	KEY

7 PIN AMP HOUSING #2293
CONTACT PIN #2201
PINS 1 & 7: KEY PLUG #2239

92" brown/gray .250 #653T

To Left Speaker
Of Station 2

red/gray .250 #653T

95" red/gray .250 #653T

To Left Speaker
Of Station 1

brown/gray .250 #653T

102" red/white .250 #653T

To Right Speaker
Of Station 1

brown/white .250 #653T

84" red/white .250 #653T

To Right Speaker
Of Station 2

brown/white .250 #653T

QTY	1	PER GAME
-----	---	----------

TITLE		Wheel Of Fortune	
DESCRIPTION # WF2018X - SPEAKER HARNESS		FILENAME	WFREV2.VSD
		DRAWN BY	MMARTIN
DATE	2/29/00	REVISED	7/23/01
		PAGE	9 OF 25

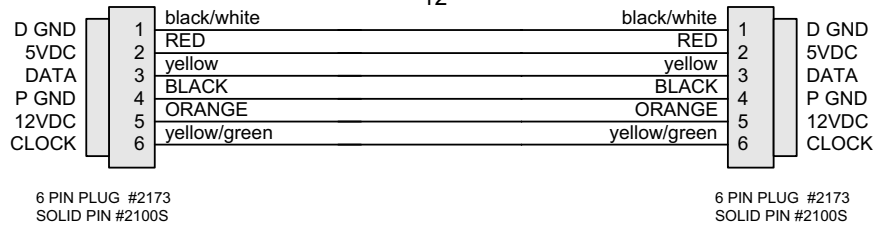
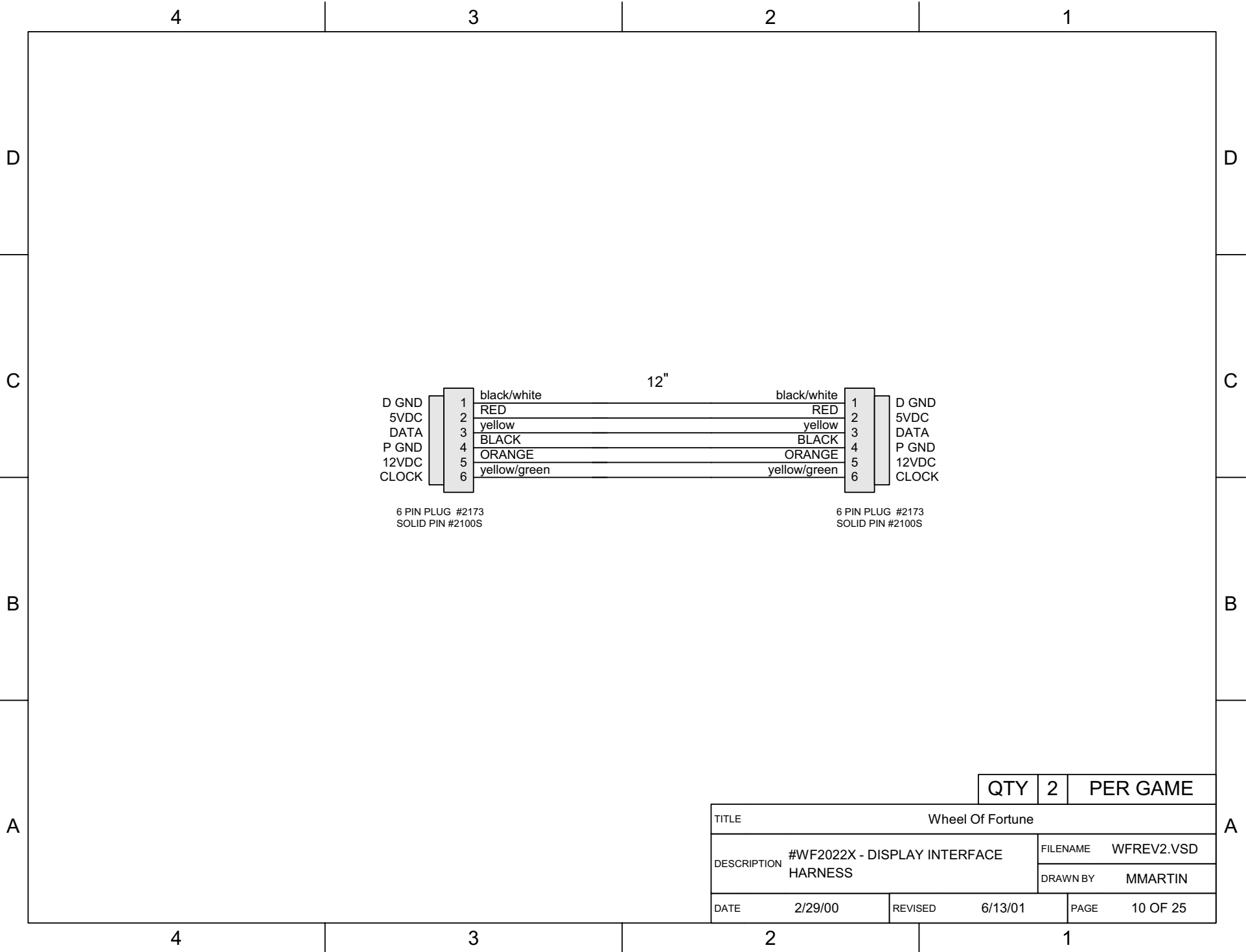

QTY	2	PER GAME
-----	---	----------

TITLE		Wheel Of Fortune	
DESCRIPTION	#WF2022X - DISPLAY INTERFACE HARNESS		FILENAME WFREV2.VSD
			DRAWN BY MMARTIN
DATE	2/29/00	REVISED	6/13/01
		PAGE	10 OF 25

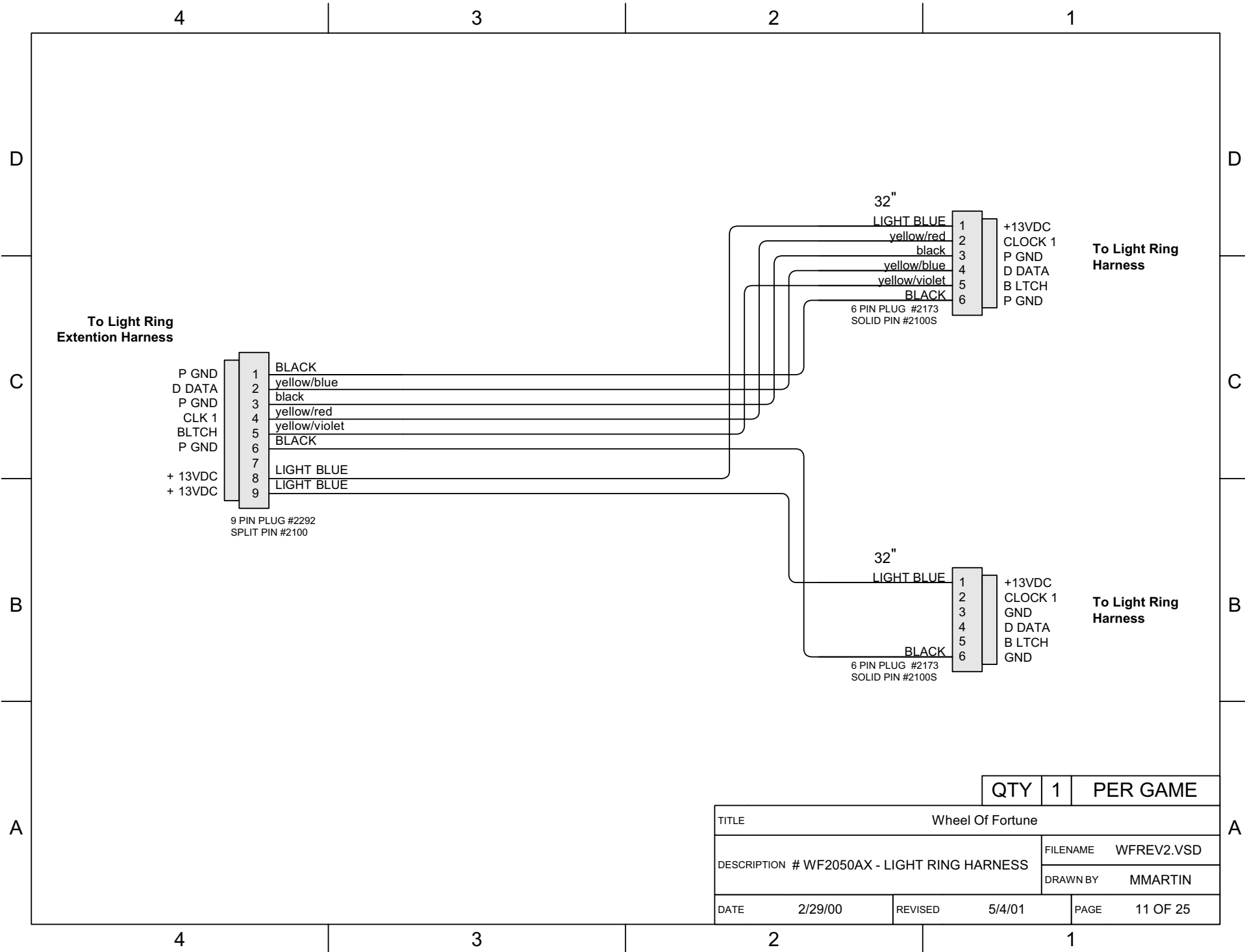

QTY	1	PER GAME
-----	---	----------

TITLE		Wheel Of Fortune	
DESCRIPTION # WF2050AX - LIGHT RING HARNESS		FILENAME	WFREV2.VSD
		DRAWN BY	MMARTIN
DATE	2/29/00	REVISED	5/4/01
		PAGE	11 OF 25

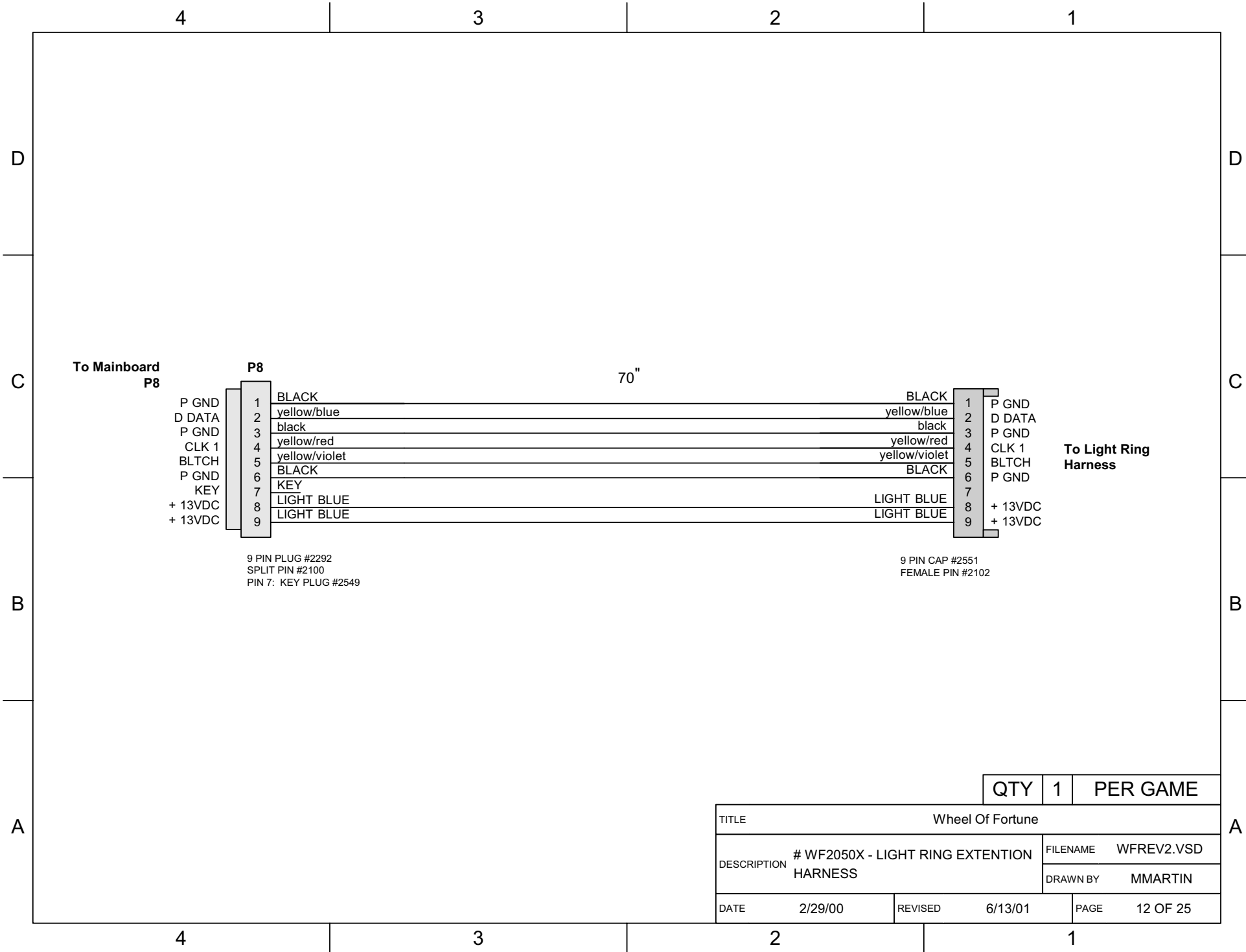

	QTY	1	PER GAME
TITLE Wheel Of Fortune			
DESCRIPTION # WF2050X - LIGHT RING EXTENTION HARNESS		FILENAME	WFREV2.VSD
		DRAWN BY	MMARTIN
DATE	2/29/00	REVISED	6/13/01
		PAGE	12 OF 25

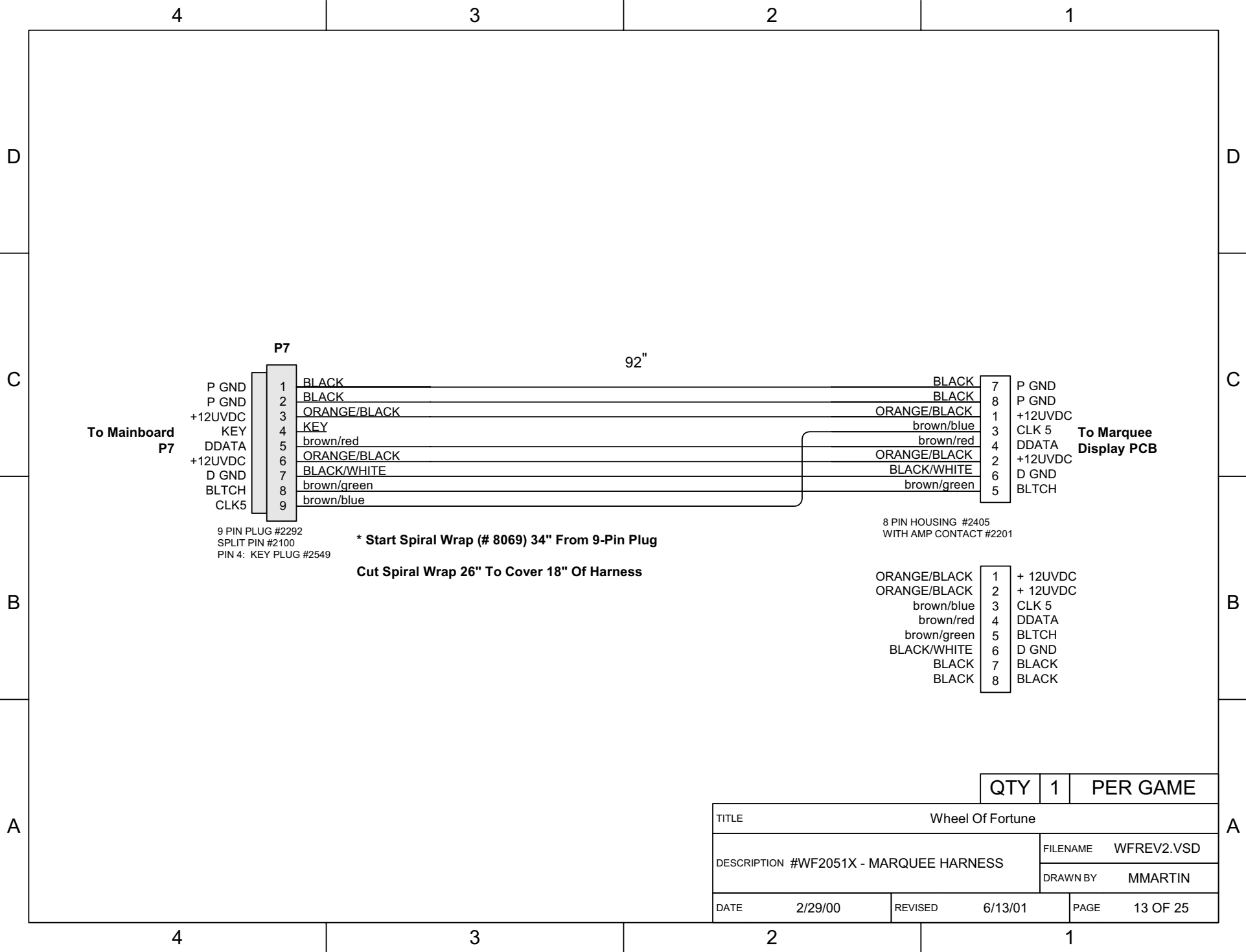

QTY	1	PER GAME
-----	---	----------

TITLE				Wheel Of Fortune			
DESCRIPTION				#WF2051X - MARQUEE HARNESS			
				FILENAME		WFREV2.VSD	
				DRAWN BY		MMARTIN	
DATE		2/29/00		REVISED		6/13/01	
				PAGE		13 OF 25	

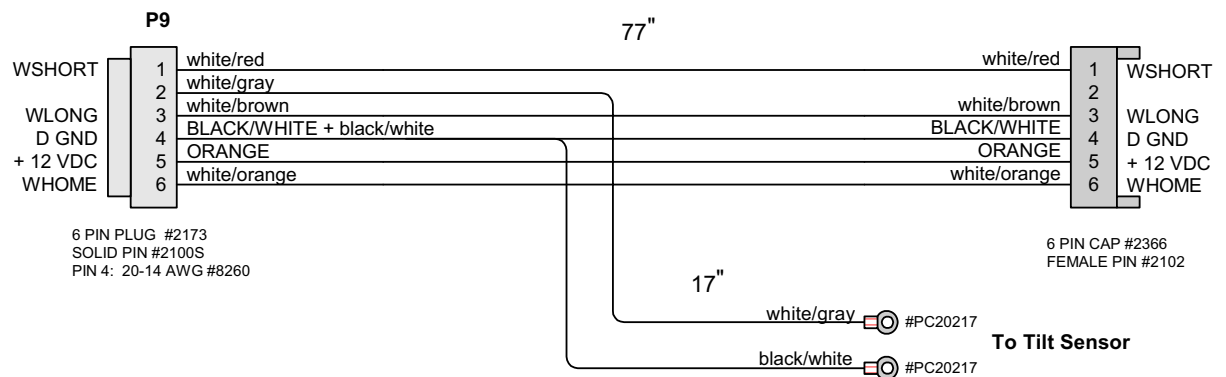
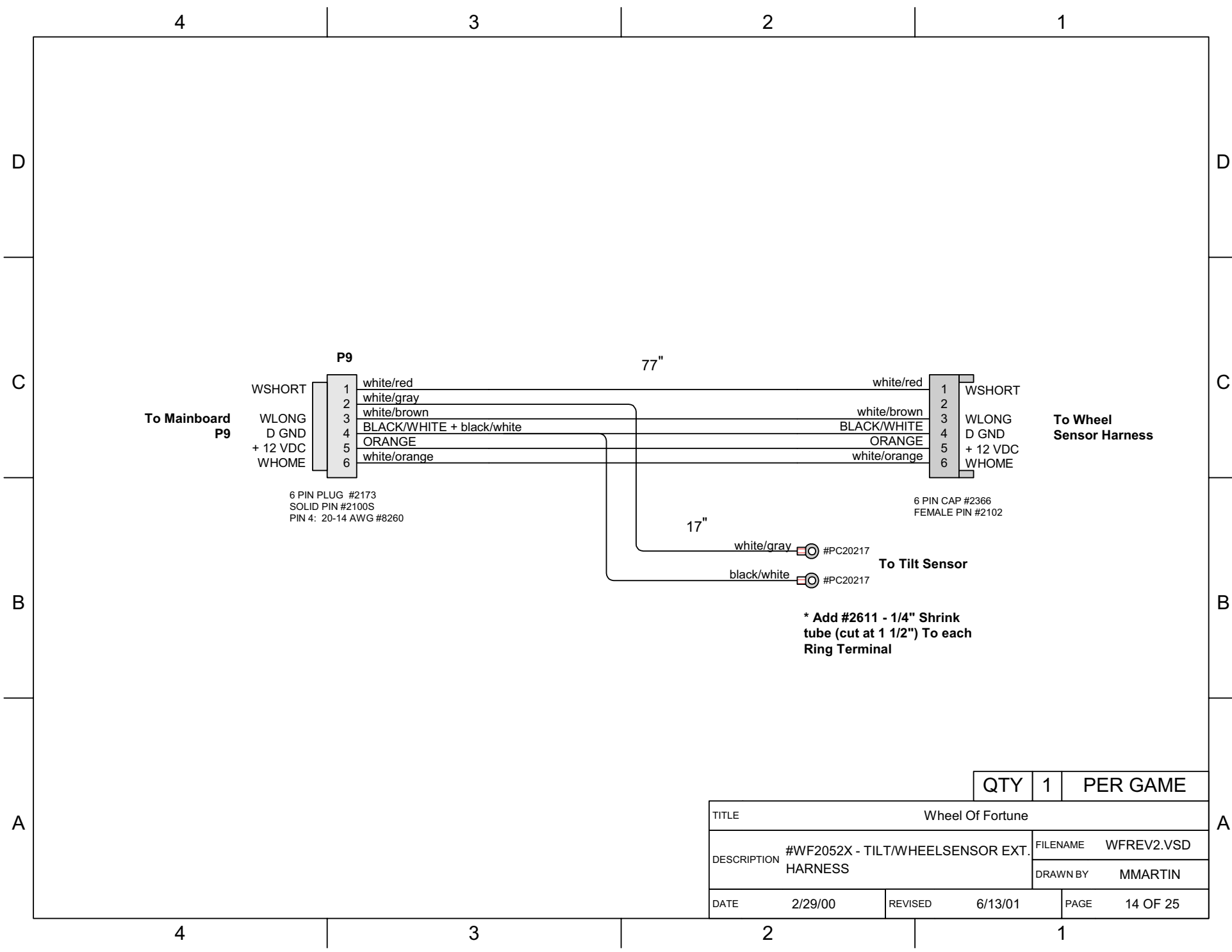

To Mainboard P9

To Wheel Sensor Harness

6 PIN PLUG #2173
SOLID PIN #2100S
PIN 4: 20-14 AWG #8260

*** Add #2611 - 1/4" Shrink tube (cut at 1 1/2") To each Ring Terminal**

QTY	1	PER GAME
-----	---	----------

TITLE		Wheel Of Fortune	
DESCRIPTION	#WF2052X - TILT/WHEELSENSOR EXT. HARNESS	FILENAME	WFREV2.VSD
		DRAWN BY	MMARTIN
DATE	2/29/00	REVISED	6/13/01
		PAGE	14 OF 25

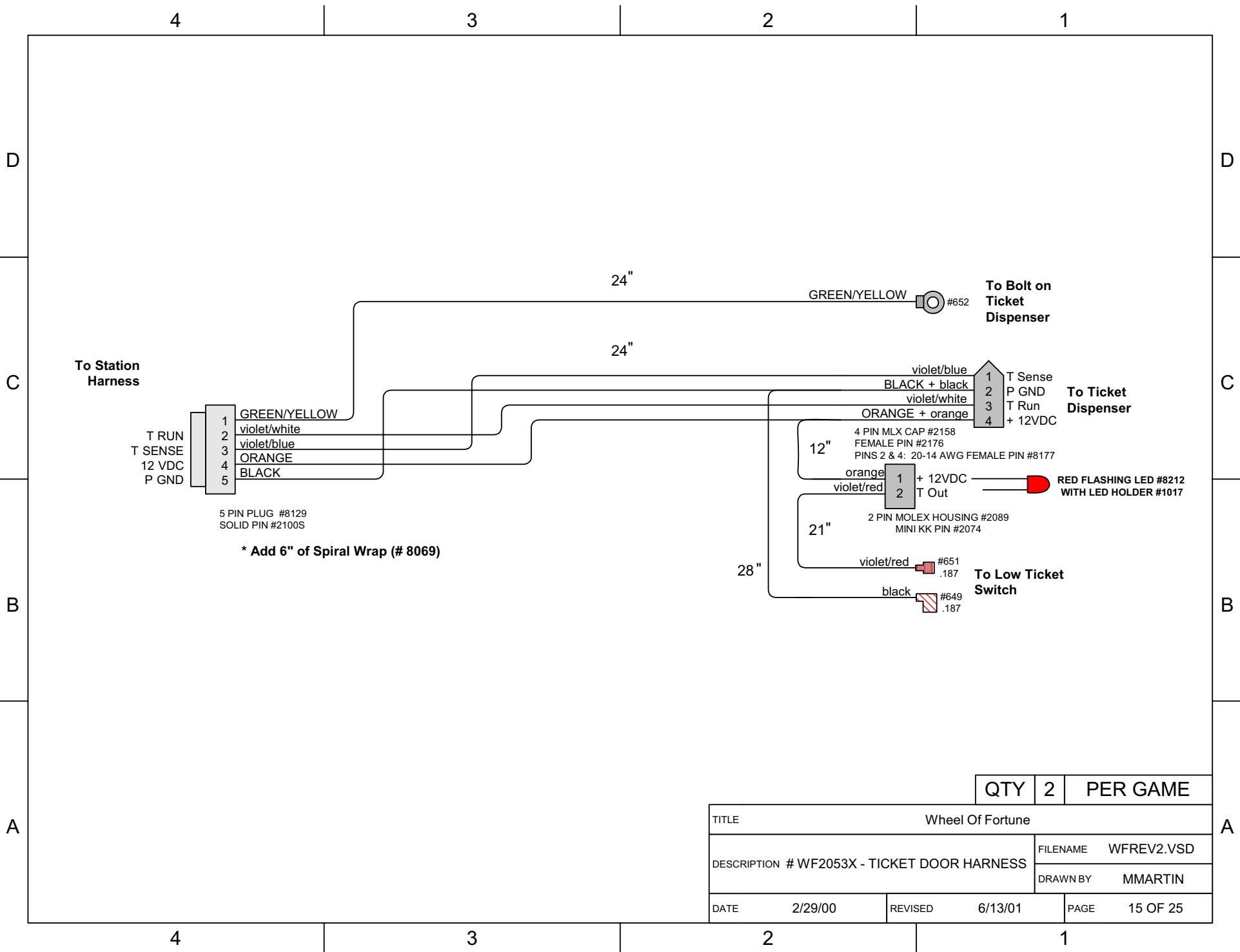

To Station
Harness

T RUN
T SENSE
12 VDC
P GND

- 1 GREEN/YELLOW
- 2 violet/white
- 3 violet/blue
- 4 ORANGE
- 5 BLACK

5 PIN PLUG #8129
SOLID PIN #2100S

* Add 6" of Spiral Wrap (# 8069)

24"

24"

GREEN/YELLOW #652

To Bolt on
Ticket
Dispenser

- 1 violet/blue
- 2 BLACK + black
- 3 violet/white
- 4 ORANGE + orange

To Ticket
Dispenser

4 PIN MLX CAP #2158
FEMALE PIN #2176
PINS 2 & 4: 20-14 AWG FEMALE PIN #8177

12" orange
violet/red

- 1 + 12VDC
- 2 T Out

RED FLASHING LED #8212
WITH LED HOLDER #1017

21" 2 PIN MOLEX HOUSING #2089
MINI KK PIN #2074

28"

- violet/red #651 .187
- black #649 .187

To Low Ticket
Switch

QTY	2	PER GAME
-----	---	----------

TITLE		Wheel Of Fortune	
DESCRIPTION # WF2053X - TICKET DOOR HARNESS		FILENAME	WFREV2.VSD
		DRAWN BY	MMARTIN
DATE	2/29/00	REVISED	6/13/01
		PAGE	15 OF 25

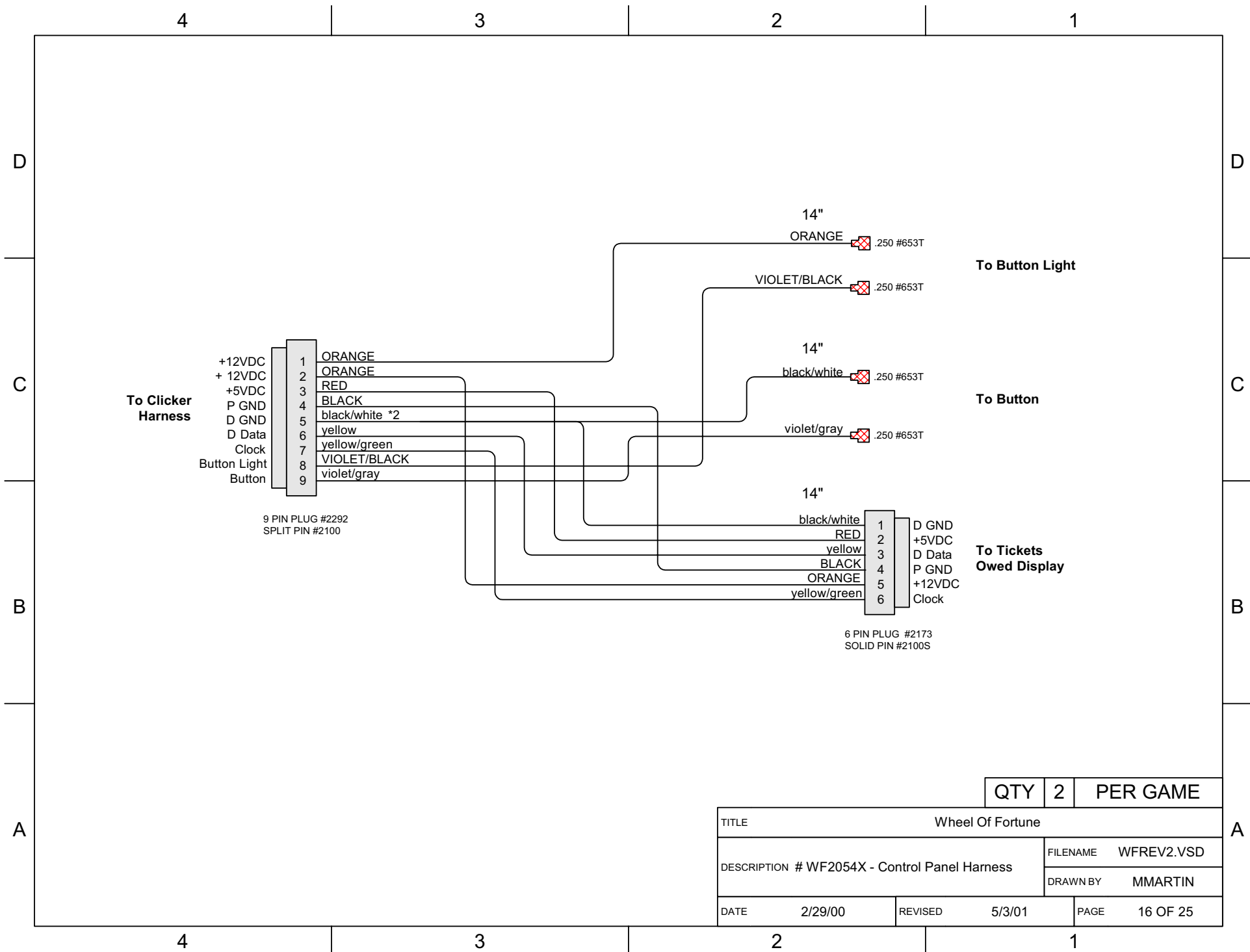

QTY	2	PER GAME
-----	---	----------

TITLE		Wheel Of Fortune	
DESCRIPTION # WF2054X - Control Panel Harness		FILENAME	WFREV2.VSD
		DRAWN BY	MMARTIN
DATE	2/29/00	REVISED	5/3/01
		PAGE	16 OF 25

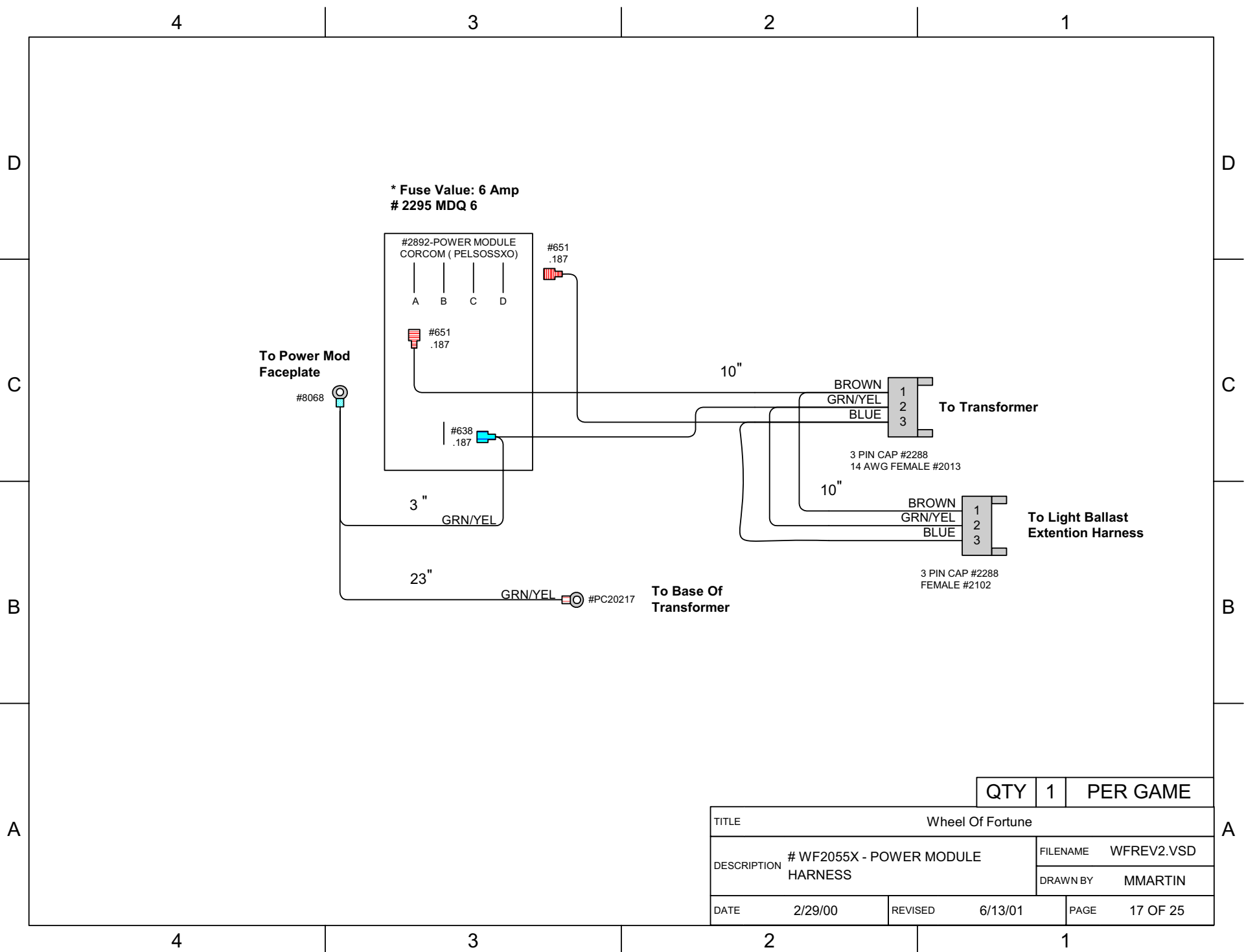

QTY 1 PER GAME

TITLE		Wheel Of Fortune	
DESCRIPTION	# WF2055X - POWER MODULE HARNESS		FILENAME WFREV2.VSD
			DRAWN BY MMARTIN
DATE	2/29/00	REVISED	6/13/01
		PAGE	17 OF 25

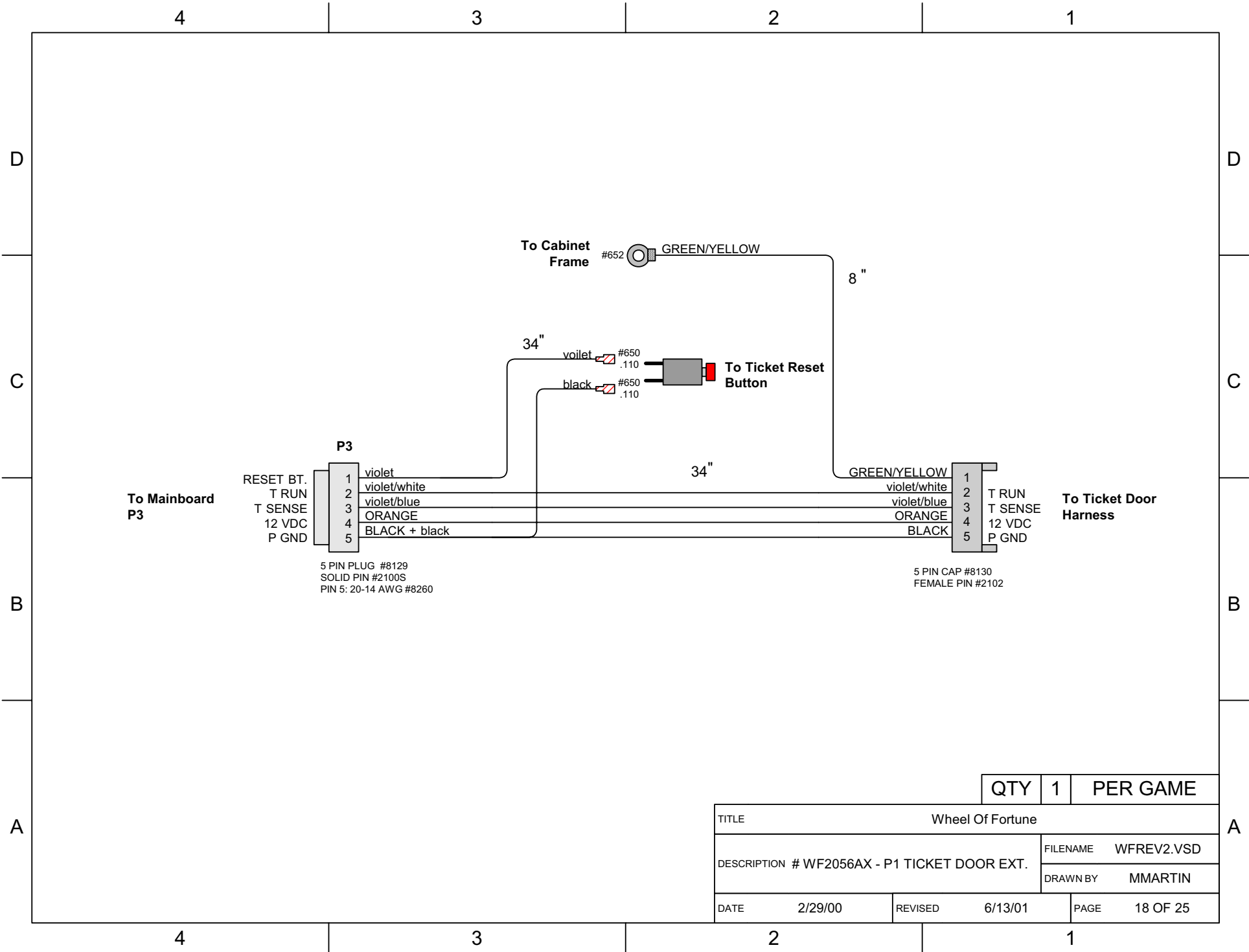

To Mainboard
P3

RESET BT.
T RUN
T SENSE
12 VDC
P GND



5 PIN PLUG #8129
SOLID PIN #2100S
PIN 5: 20-14 AWG #8260

1 violet
2 violet/white
3 violet/blue
4 ORANGE
5 BLACK + black

To Cabinet
Frame #652



8"

34"



To Ticket Reset
Button

34"

GREEN/YELLOW
violet/white
violet/blue
ORANGE
BLACK

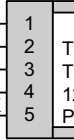

5 PIN CAP #8130
FEMALE PIN #2102

1
2
3
4
5

T RUN
T SENSE
12 VDC
P GND

To Ticket Door
Harness

QTY	1	PER GAME
-----	---	----------

TITLE		Wheel Of Fortune	
DESCRIPTION # WF2056AX - P1 TICKET DOOR EXT.		FILENAME	WFREV2.VSD
		DRAWN BY	MMARTIN
DATE	2/29/00	REVISED	6/13/01
PAGE		18 OF 25	

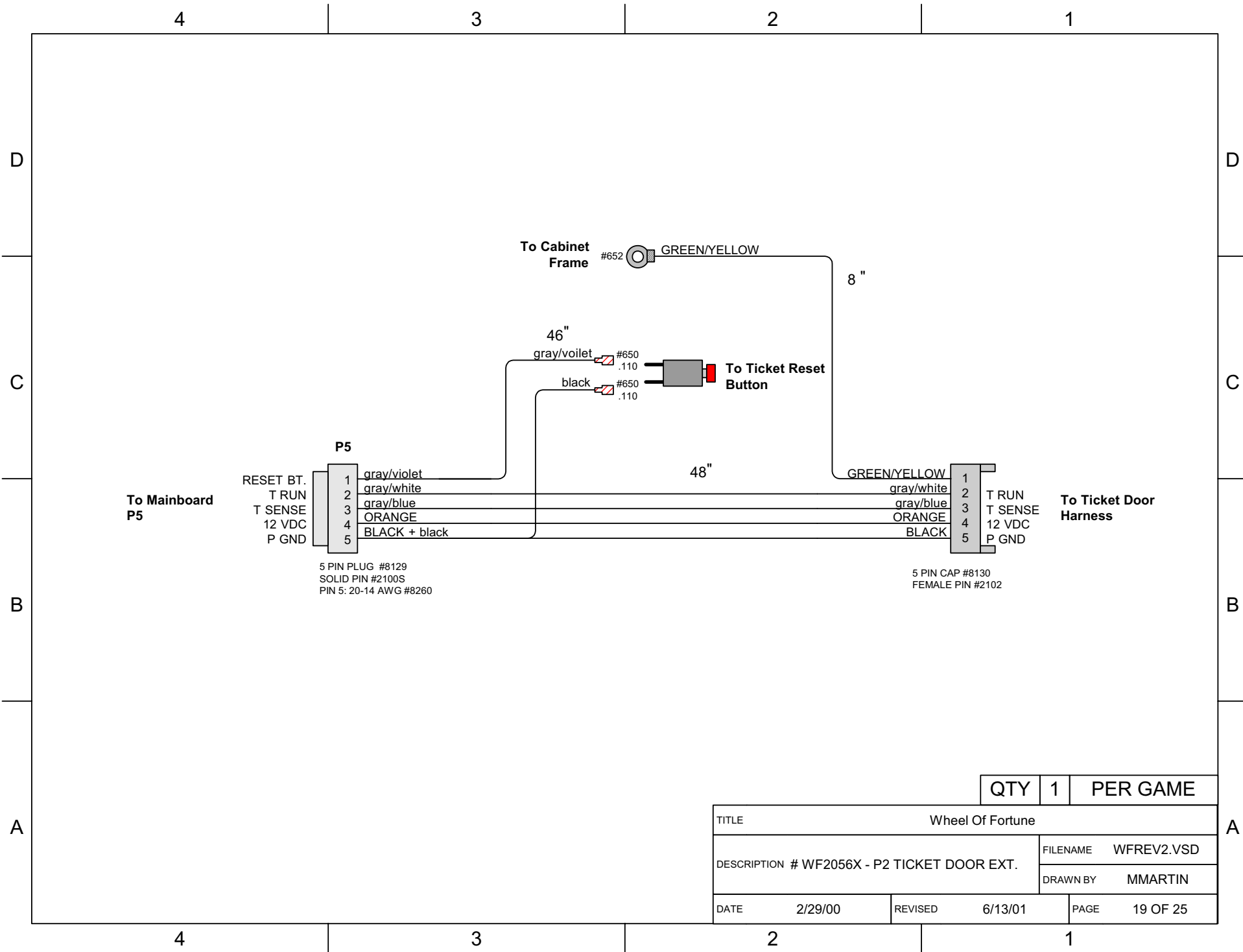

QTY	1	PER GAME
-----	---	----------

TITLE		Wheel Of Fortune	
DESCRIPTION # WF2056X - P2 TICKET DOOR EXT.		FILENAME	WFREV2.VSD
		DRAWN BY	MMARTIN
DATE	2/29/00	REVISED	6/13/01
		PAGE	19 OF 25

4

3

2

1

D

D

C

C

B

B

A

A

To Wheel Motor
Extention Harness

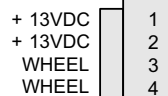

4 PIN PLUG #2099
SOLID PIN #2100S

LIGHT BLUE
LIGHT BLUE
BLACK/BLUE
BLACK/BLUE

27"

LIGHT BLUE
LIGHT BLUE
BLACK/BLUE
BLACK/BLUE

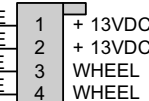

4 PIN CAP #2101
FEMALE PIN #2102

To Wheel Motor
Assembly

QTY	1	PER GAME
-----	---	----------

TITLE	Wheel Of Fortune		
DESCRIPTION	# WF2057AX - WHEEL MOTOR HARNESS		FILENAME WFREV2.VSD
			DRAWN BY MMARTIN
DATE	2/29/00	REVISED	5/3/01
		PAGE	20 OF 25

4

3

2

1

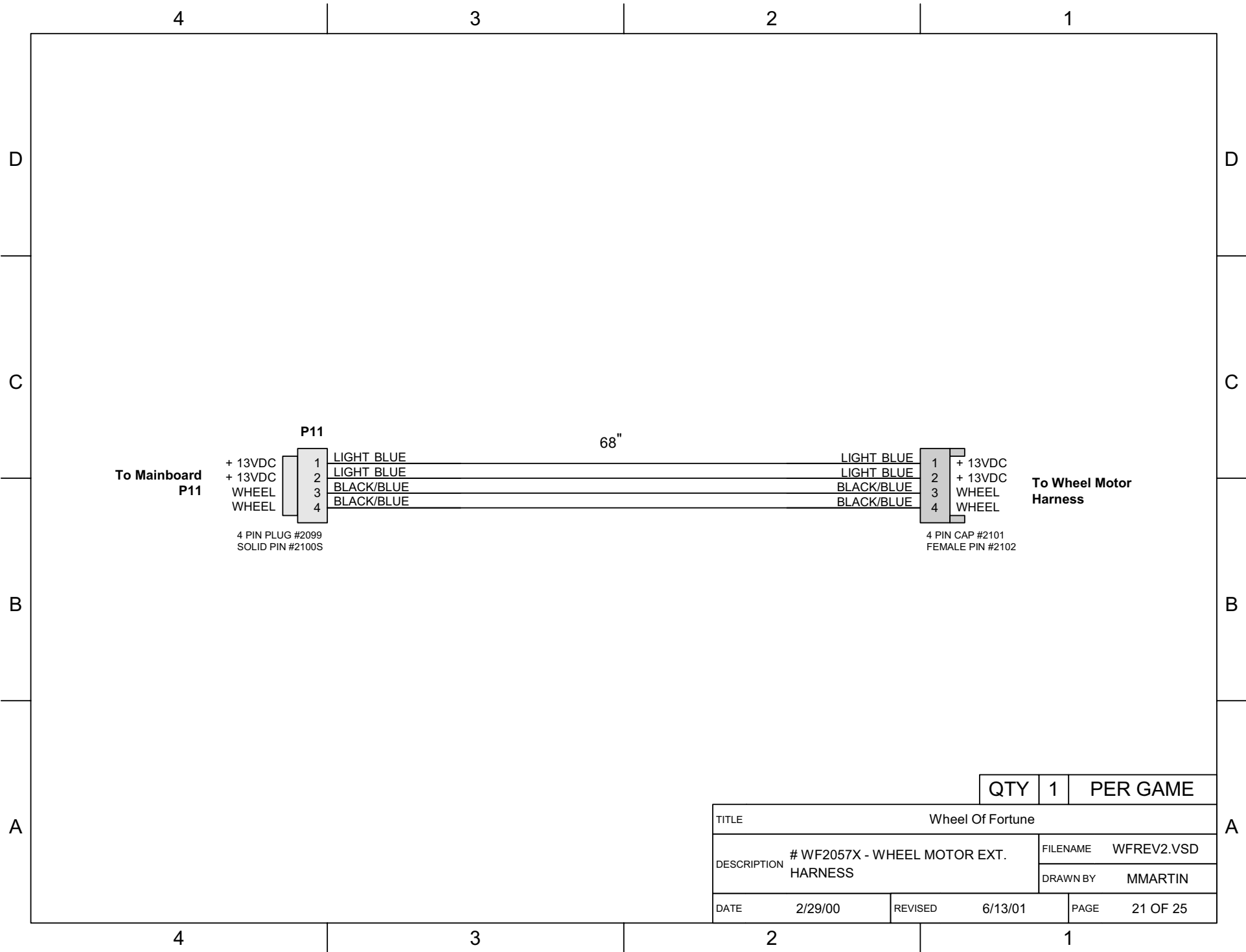

To Mainboard
P11

+ 13VDC
+ 13VDC
WHEEL
WHEEL

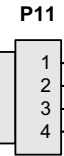

LIGHT BLUE
LIGHT BLUE
BLACK/BLUE
BLACK/BLUE

68"

LIGHT BLUE
LIGHT BLUE
BLACK/BLUE
BLACK/BLUE

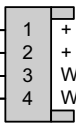

+ 13VDC
+ 13VDC
WHEEL
WHEEL

To Wheel Motor
Harness

4 PIN PLUG #2099
SOLID PIN #2100S

4 PIN CAP #2101
FEMALE PIN #2102

QTY	1	PER GAME
-----	---	----------

TITLE		Wheel Of Fortune	
DESCRIPTION		FILENAME	WFREV2.VSD
		DRAWN BY	MMARTIN
DATE	2/29/00	REVISED	6/13/01
		PAGE	21 OF 25

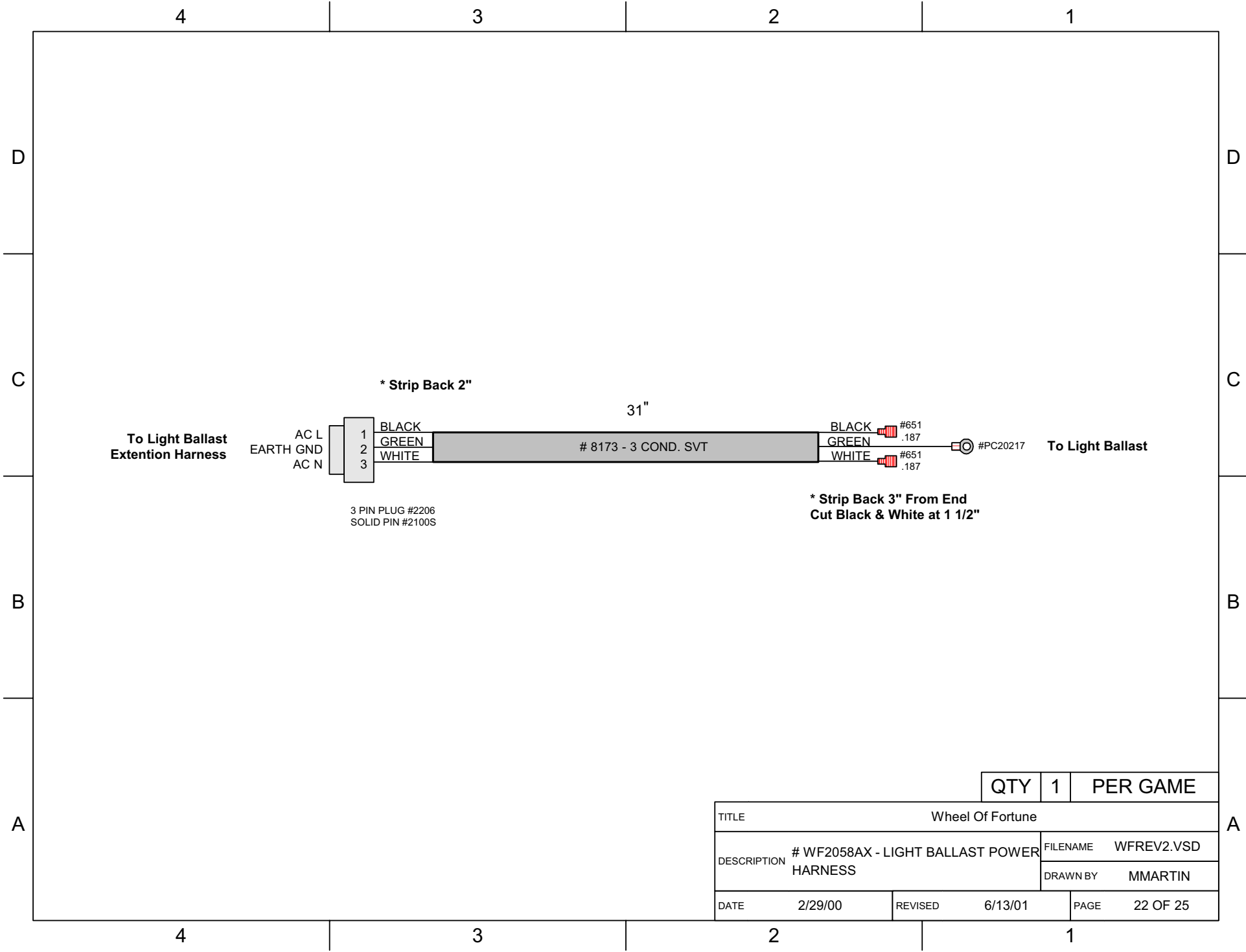

To Light Ballast
Extention Harness

AC L
EARTH GND
AC N

1 BLACK
2 GREEN
3 WHITE

3 PIN PLUG #2206
SOLID PIN #2100S

* Strip Back 2"

8173 - 3 COND. SVT

31"

BLACK #651
GREEN #651
WHITE #651

* Strip Back 3" From End
Cut Black & White at 1 1/2"

#PC20217

To Light Ballast

QTY	1	PER GAME
-----	---	----------

TITLE		Wheel Of Fortune	
DESCRIPTION	# WF2058AX - LIGHT BALLAST POWER HARNES		FILENAME WFREV2.VSD
			DRAWN BY MMARTIN
DATE	2/29/00	REVISED	6/13/01
		PAGE	22 OF 25

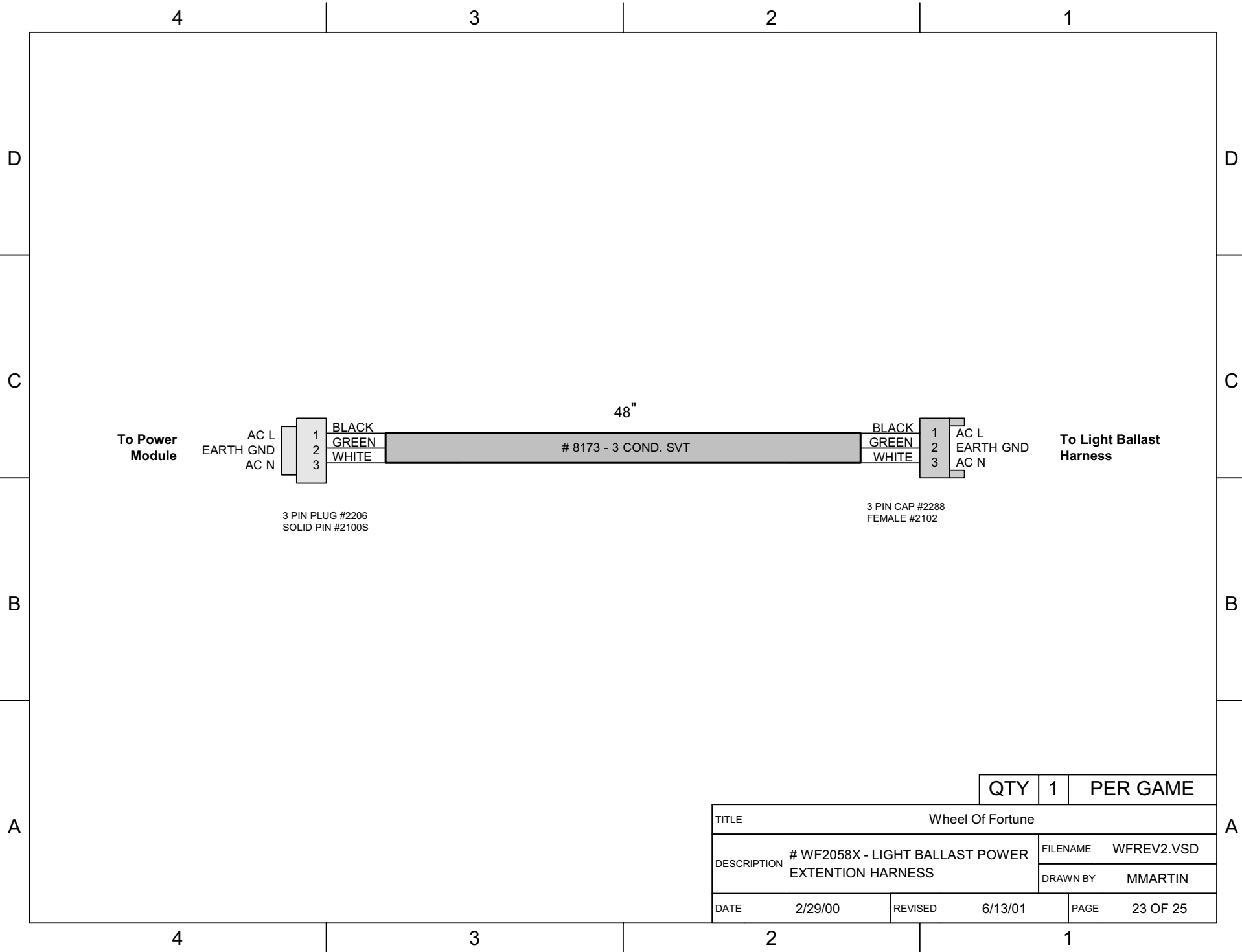

QTY	1	PER GAME
-----	---	----------

TITLE	Wheel Of Fortune		
DESCRIPTION	# WF2058X - LIGHT BALLAST POWER EXTENTION HARNESS		FILENAME WFREV2.VSD
			DRAWN BY MMARTIN
DATE	2/29/00	REVISED	6/13/01
		PAGE	23 OF 25

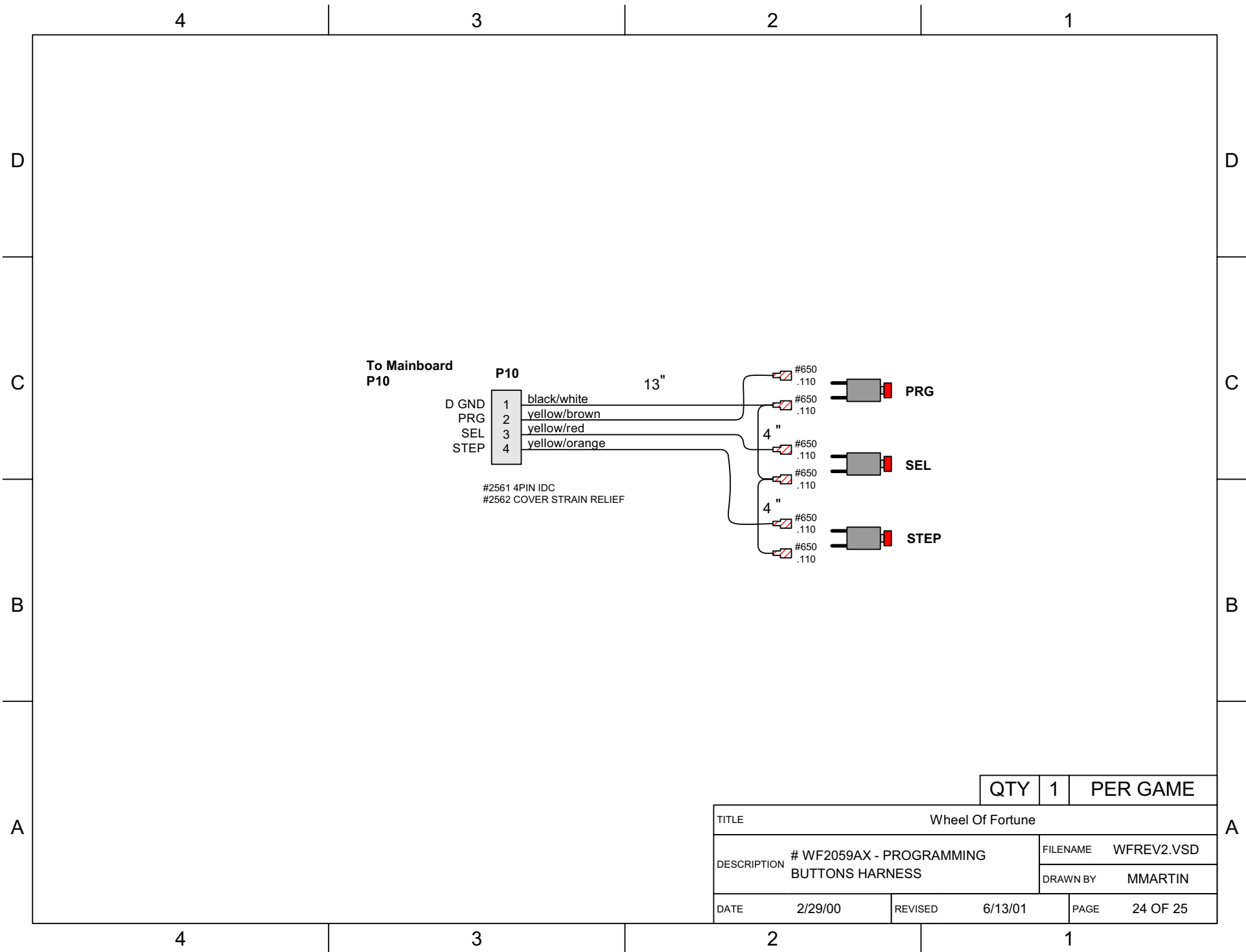

QTY	1	PER GAME
------------	----------	-----------------

TITLE		Wheel Of Fortune	
DESCRIPTION		FILENAME	WFREV2.VSD
		DRAWN BY	MMARTIN
DATE	2/29/00	REVISED	6/13/01
		PAGE	24 OF 25

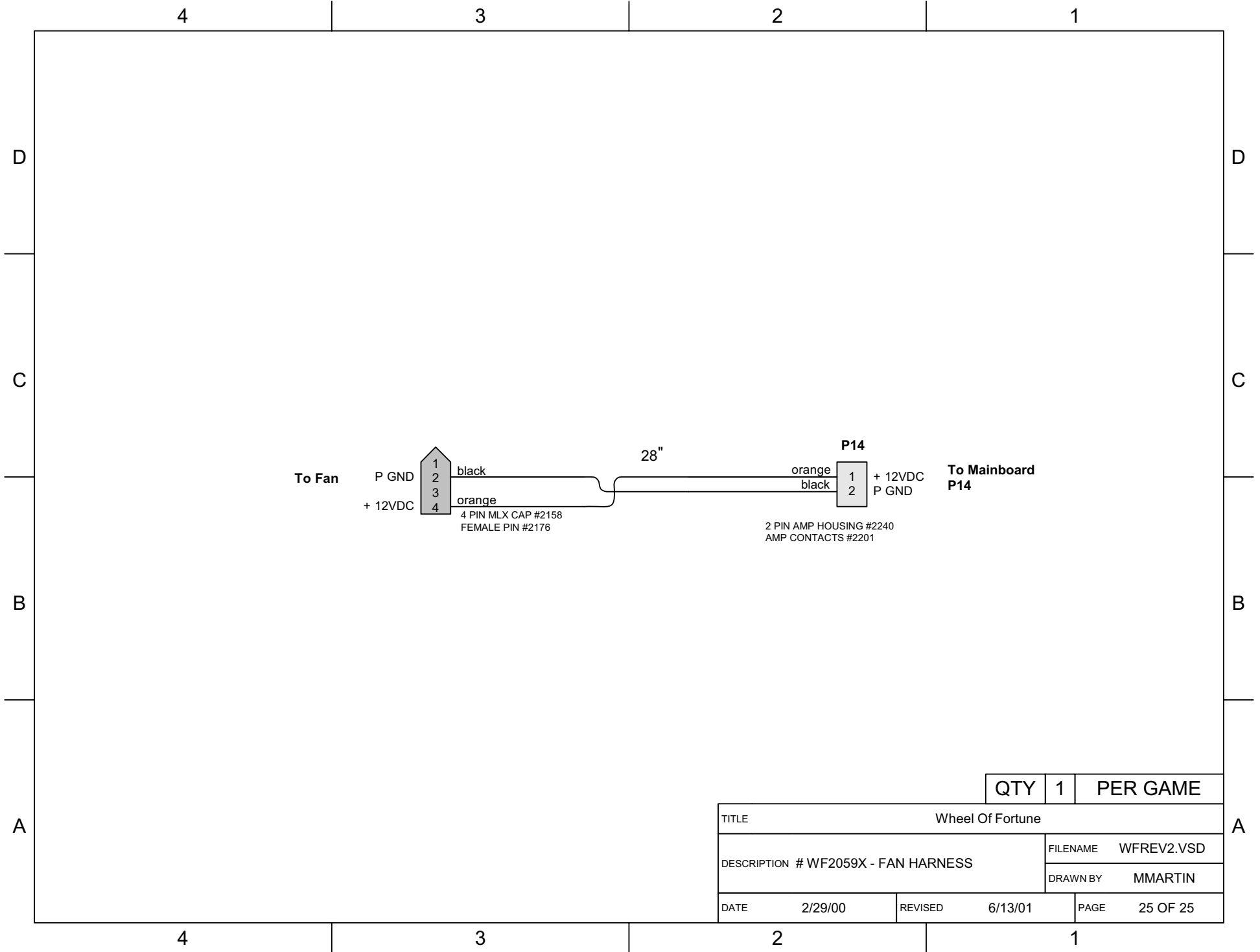

QTY	1	PER GAME
-----	---	----------

TITLE		Wheel Of Fortune	
DESCRIPTION # WF2059X - FAN HARNESS		FILENAME	WFREV2.VSD
		DRAWN BY	MMARTIN
DATE	2/29/00	REVISED	6/13/01
		PAGE	25 OF 25

Warranty

I.C.E warrants all components in the **SUPER CHEXX**" game to be free of defects in materials and workmanship for a period of ninety days from the date of purchase.

This warranty does not cover items damaged due to normal wear and tear, subjected to abuse, improperly assembled by the end user, modified, repaired, or operated in a fashion other than that described in the service manual.

If your **SUPER CHEXX**" game fails to conform to the above-mentioned warranty, I.C.E.'s sole responsibility shall be at its discretion to repair or replace any defective component with a new or remanufactured component of equal to or greater O.E.M. specification.

I.C.E. will assume no liability whatsoever, for costs associated with labor to replace defective parts, or travel time associated therein.

I.C.E.'s obligation will be to ship free of charge, replacement parts by U.P.S. Ground, U.S. mail, or other comparable shipping means. Any express mail or overnight shipping expense is at the cost of the purchaser.

Products will be covered under warranty only when:

- The serial number of the game with the defective parts is given.
- The serial number of the defective part, if applicable, is given.
- Defective parts are returned to I.C.E., shipping pre-paid, in a timely fashion, if requested by I.C.E.
- A copy of the sales receipt is available as proof of purchase upon request of I.C.E.

I.C.E. distributors are independent, privately owned and operated. In their judgment, they may sell parts or accessories other than those manufactured by I.C.E. We cannot be responsible for the quality, suitability, or safety of any non-I.C.E. part, or any modification, including labor, which is performed by such a distributor.